

Passe-fils spéciaux HELAVIA® en caoutchouc polychloroprène



HELAVIA®



type	code article		type	code article		type	code article	
15-010	0257 0020 010	100	15-580 SNCF*	0257 0168 010	100	15-734	0257 0004 010	15
15-033	0257 0001 010	100	15-595	0257 0034 010	100	15-742	0257 0063 010	100
15-076	0257 0003 010	100	15-610 SNCF*	0257 0035 010	1	15-746	0257 0064 010	100
15-093	0257 0005 010	100	15-611	0257 0036 010	100	15-803 SNCF*	0257 0066 010	1
15-187	0257 0008 010	100	15-612	0257 0037 010	100	15-808	0257 0067 010	50
15-309	0257 0009 010	25	15-613	0257 0038 010	100	15-819 SNCF*	0257 0071 010	1
15-377	0257 0012 010	100	15-614	0257 0039 010	100	15-820 SNCF*	0257 0072 010	1
15-394	0257 0033 010	100	15-644**	0257 0040 010	25	15-853	0257 0073 010	100
15-519	0257 0017 010	100	15-645	0257 0041 010	100	15-854	0257 0075 010	100
15-539 SNCF*	0257 0118 010	100	15-679	0257 0061 010	100			
15-565	0257 0019 010	100	15-687	0257 0062 010	100			

* en caoutchouc Nitrile
** en caoutchouc EPDM

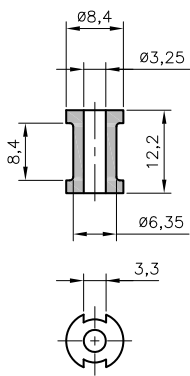

15-611
0257 0036 010

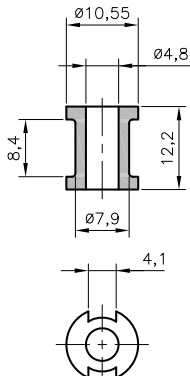

15-612
0257 0037 010

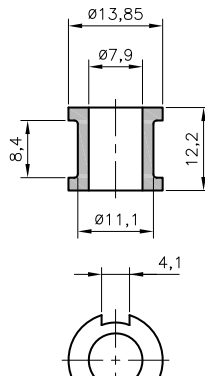

15-613
0257 0038 010

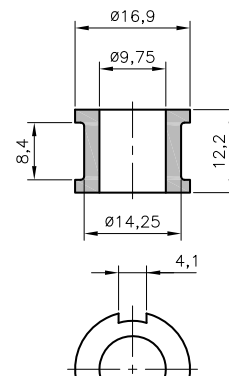

15-614
0257 0039 010

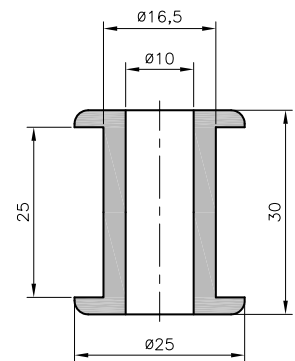

15-645
0257 0041 010

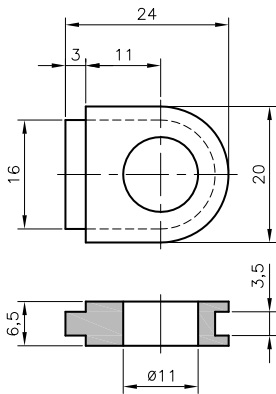

15-746
0257 0064 010

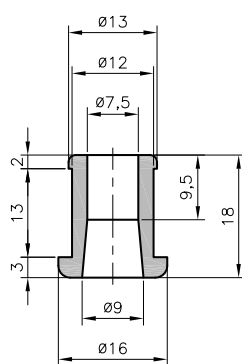

15-565
0257 0019 010

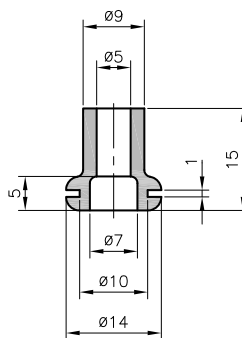

15-187
0257 0008 010

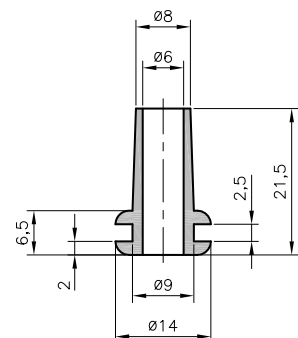

15-679
0257 0061 010

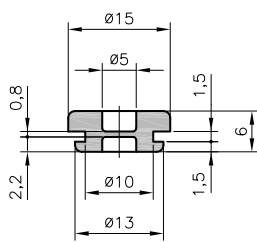

15-377
0257 0012 010

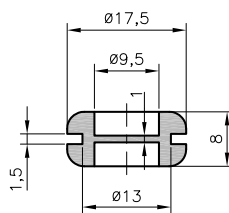

15-076
0257 0003 010

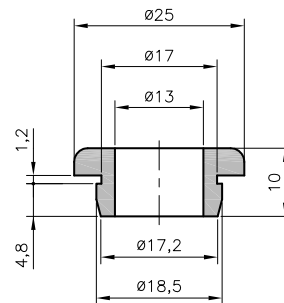

15-687
0257 0062 010



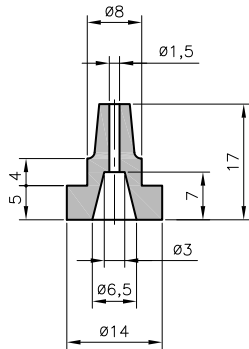

15-394
0257 0033 010

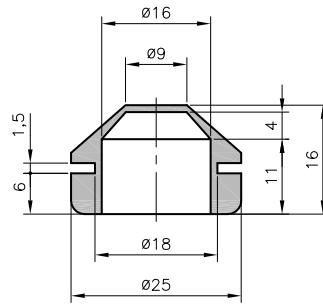

15-093
0257 0005 010

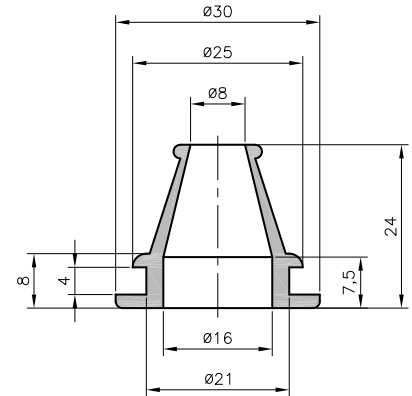

15-033
0257 0001 010

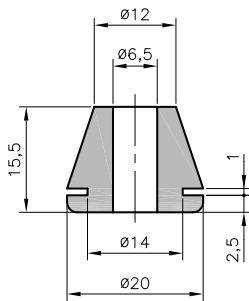

15-519
0257 0017 010

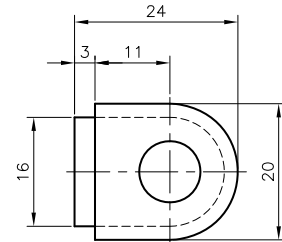
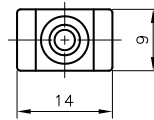

15-010
0257 0020 010

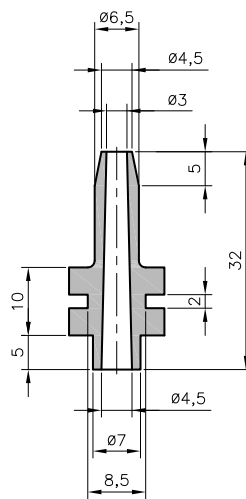

15-595
0257 0034 010

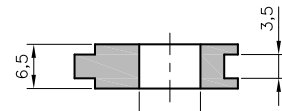

15-010
0257 0020 010

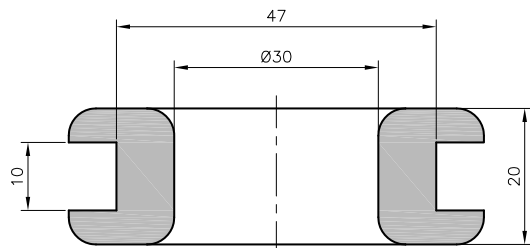

15-644**
0257 0040 010

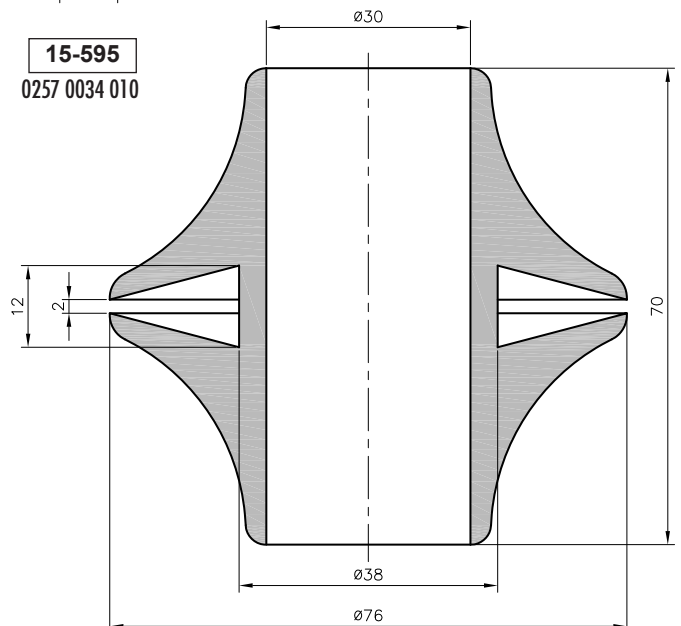
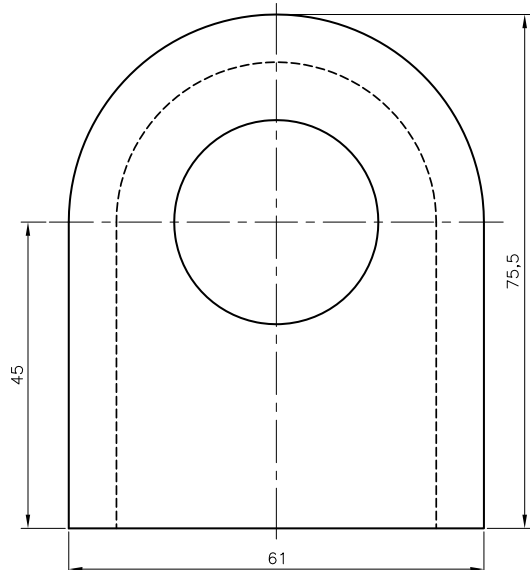

15-309
0257 0009 010

** en caoutchouc EPDM

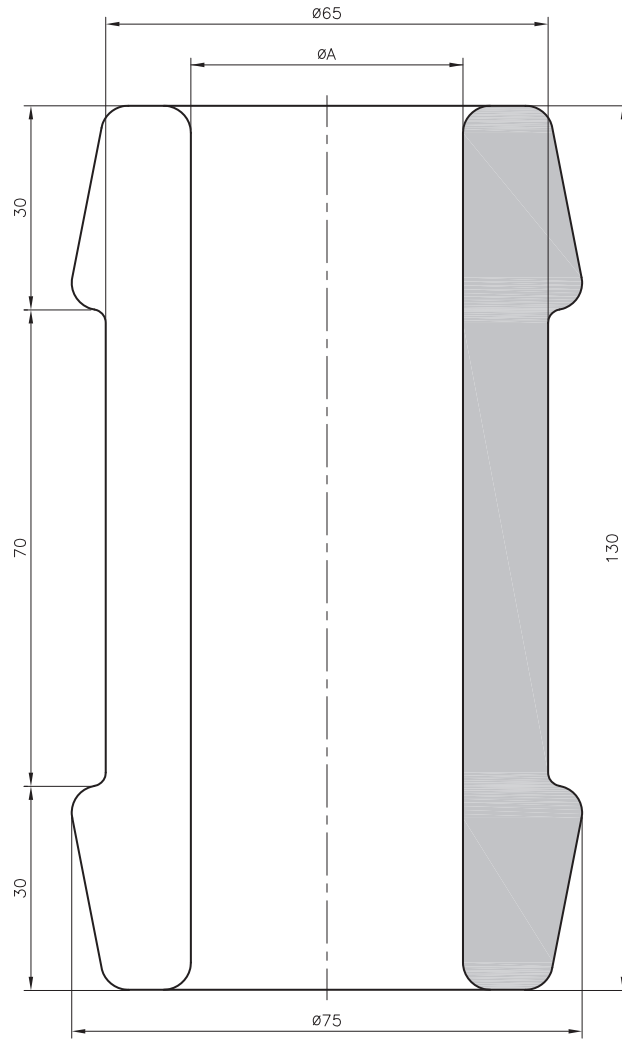

type	$\varnothing A$ mm	B mm
15-610	49	1,5
15-803	42	3
15-819	40	3
15-820	49	3

15-610*
0257 0035 010

15-803*
0257 0066 010

15-819*
0257 0071 010

15-820*
0257 0072 010

* en caoutchouc Nitrile

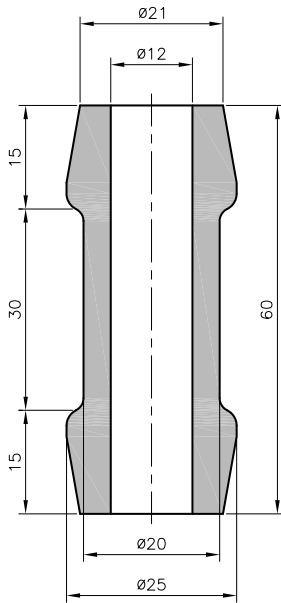

15-539*
0257 0118 010

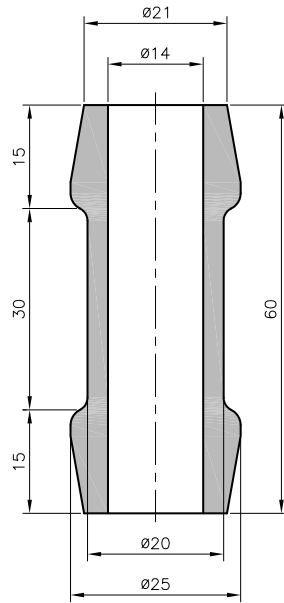

15-580*
0257 0168 010

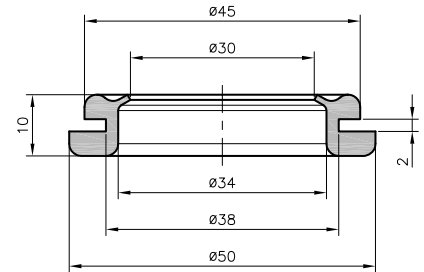

15-808
0257 0067 010

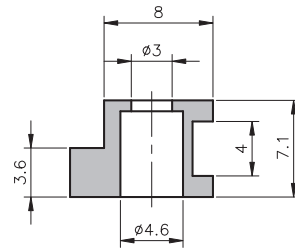

15-853
0257 0073 010

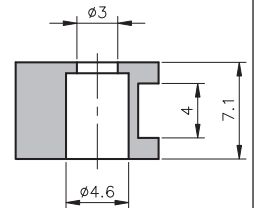

15-854
0257 0075 010

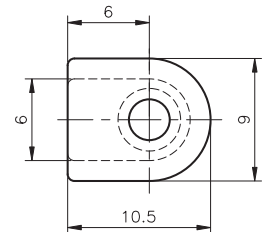
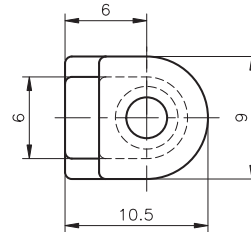

Nouveau

Nouveau

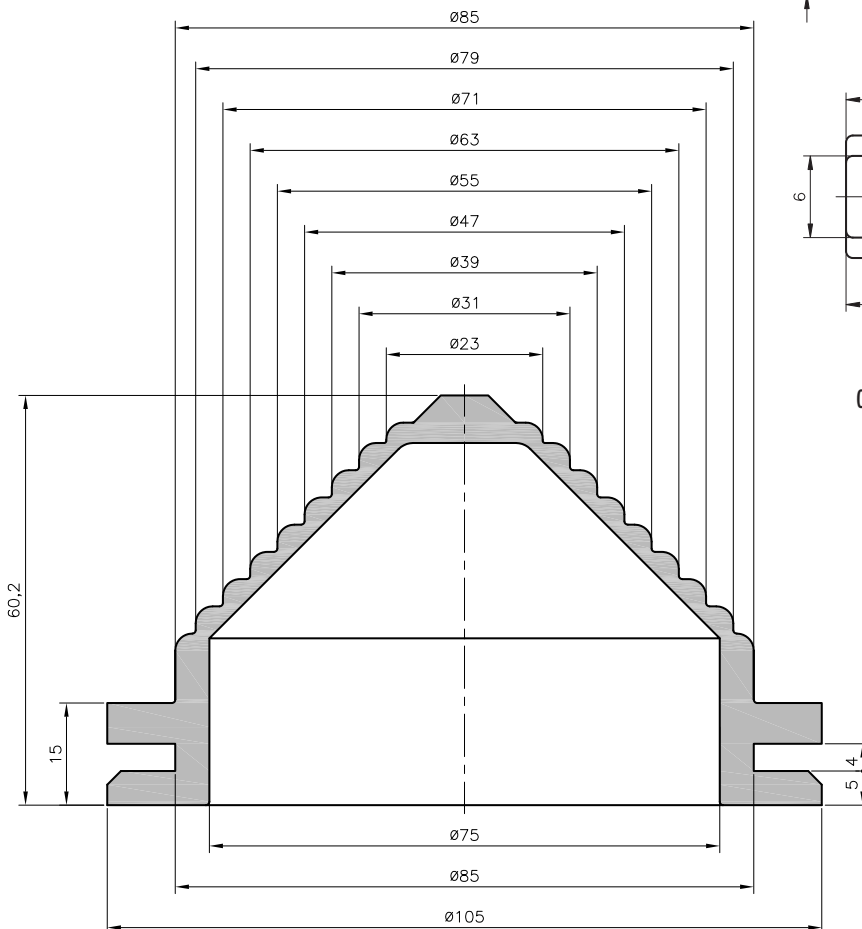

15-734
0257 0004 010

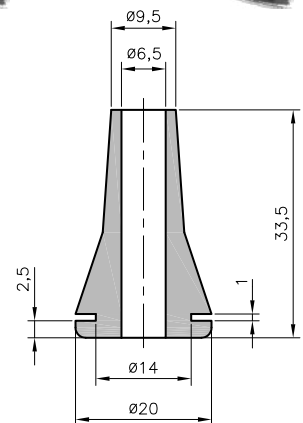

15-742
0257 0063 010

* en caoutchouc Nitrile