



Paulmann

### Safety Instructions

1, 2, 3, 4, 5, 6, 7, 10, 14, 19, 28, 33, 34



### Info

www.paulmann.com

Paulmann Licht GmbH  
Quezinger Feld 2  
31832 Springe  
Germany

www.paulmann.com

Art.-Nr.: 70895  
(+MA 326) PYW 03/18

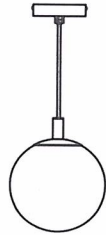

max. 1x20W LED



incl.

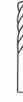
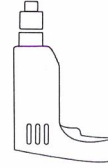

A

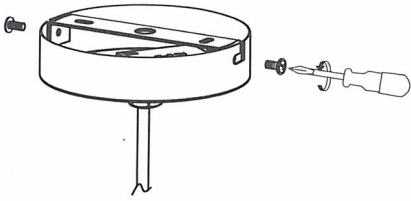

B

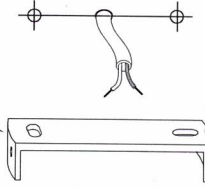
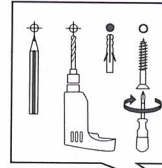

Safety Instructions  
Nr. 4, 5, 6, 7



C

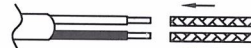
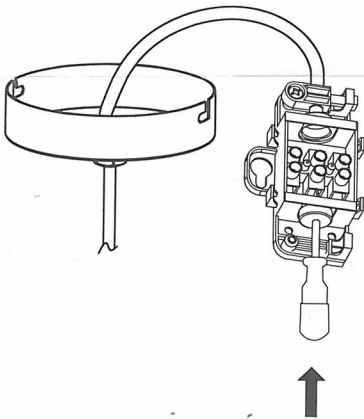

230V

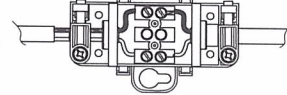
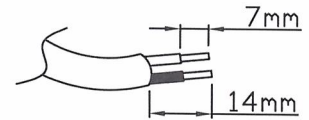
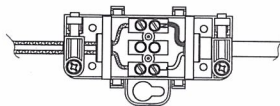

230V

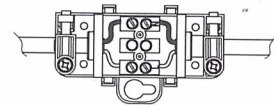

D

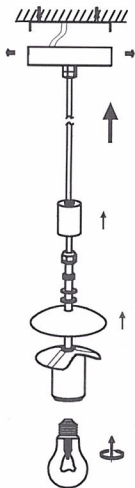

E

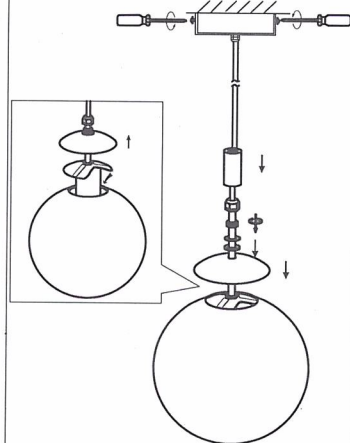

F

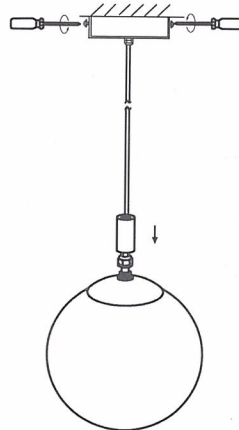

G

