

CONTENTS	Page
1. Use	1
2. Technical characteristics	1
3. Dimensions	2
4. Connection	2
5. Removal	3
6. Installation	4
7. Operation	5
8. Settings	6
9. Performance	8
10. Care	9
11. Standards and certifications	9
12. Troubleshooting	9

1. USE

This device allows a light source to be controlled automatically by detecting movement in a monitored area. It can be installed outdoors (car park, driveway) and also in places like cellars, test rooms, laboratories. Motion sensors with 270° and 360° detection angle. Detection type: infrared (PIR) Mounting type: ceiling, wall

2. TECHNICAL CHARACTERISTICS

Voltage: 110 - 240 V~
 Frequency: 50/60 Hz
 No-load power consumption: 0.6 W
 Output via normally open contact connected to the phase
 Wiring: 2 x 2.5 mm²
 Number of terminals: 4
 Terminal type: screwless
 Stripping length: 8 mm
 Weight: 200 g
 Impact resistance: IK04
 Penetration by solid and liquid matter: IP55
 Usage temperature: - 25°C to + 45°C
 Storage temperature: - 25°C to + 70°C

2. TECHNICAL CHARACTERISTICS (continued)

Products approved for 40,000 operations
 Mains zero breaking: in order to limit the effect of induced currents on cut-off relays by fluorescent loads in particular, this sensor breaks the voltage at mains zero. Switching occurs when the voltage is at point 0 which ensures a longer life for sources and for the sensor.

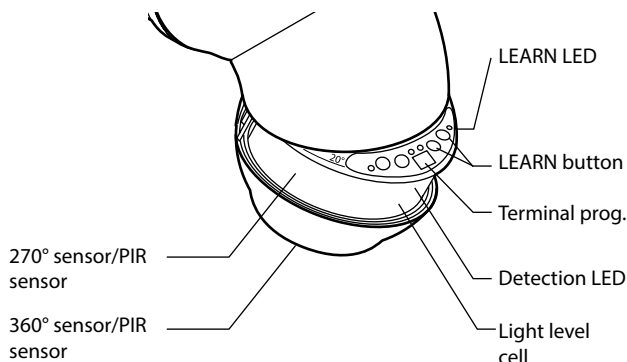

①		②		③		④		⑤		⑥		⑦		⑧		
230 V~	2000 W	8.5 A	1000 VA	4.3 A	1000 VA	4.3 A	10x(2x36 W)	4.3 A	250 W	1 A	250 W	1 A	250 W	1 A	500 VA	2.1 A
110 V~	1000 W	8.5 A	500 VA	4.3 A	500 VA	4.3 A	5x(2x36 W)	4.3 A	125 W	1 A	125 W	1 A	125 W	1 A	250 VA	

- 1 - Halogen bulbs
- 2 - ELV halogen, compact fluorescent and fluorescent bulbs with separate electronic ballast
- 3 - ELV halogen, compact fluorescent and fluorescent bulbs with separate ferromagnetic ballast
- 4 - Fluorescent tubes
- 5 - Compact fluorescent bulbs with built-in electronic ballast
- 6 - Compact fluorescent bulbs with built-in ferromagnetic ballast
- 7 - LED bulbs

- 8 - Contactor
- 9 - Motor

⑨		⑧	
(M)		(C)	
230 V~	500 VA	2.1 A	I max. ≤ 2.1 A
110 V~	250 VA	max.	
U ≤ 30 V=	2.1 A max.		

3. DIMENSIONS

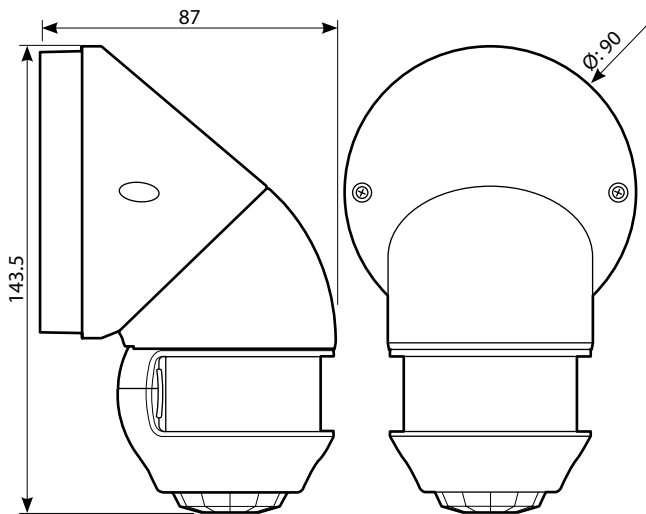

4. CONNECTION

4.1 Wiring with auxiliary control:

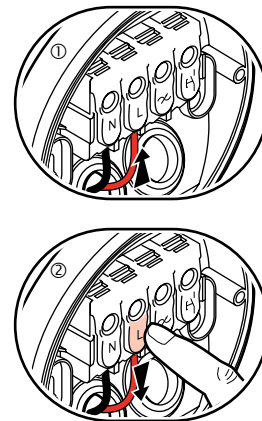
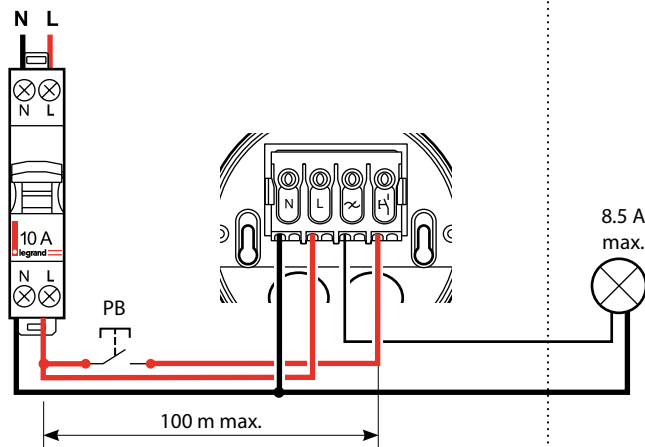

4.2 Wiring for several loads connected in parallel

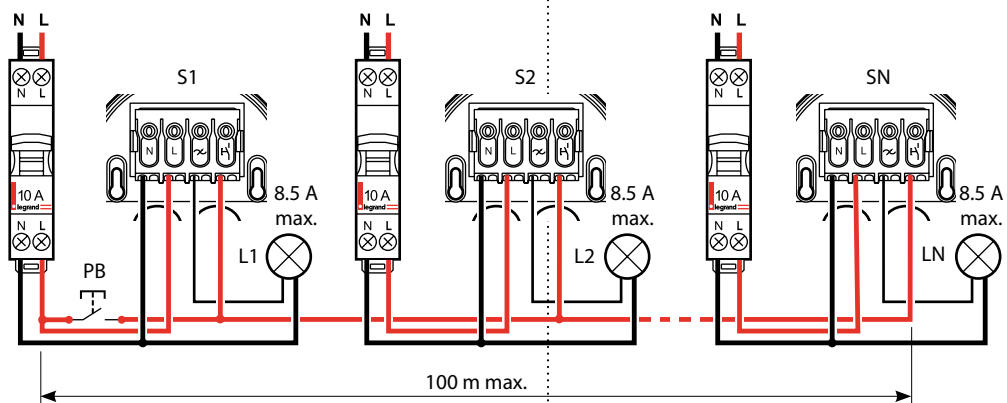

4. CONNECTION (continued)

■ **4.3 Wiring for a single load connected in parallel**

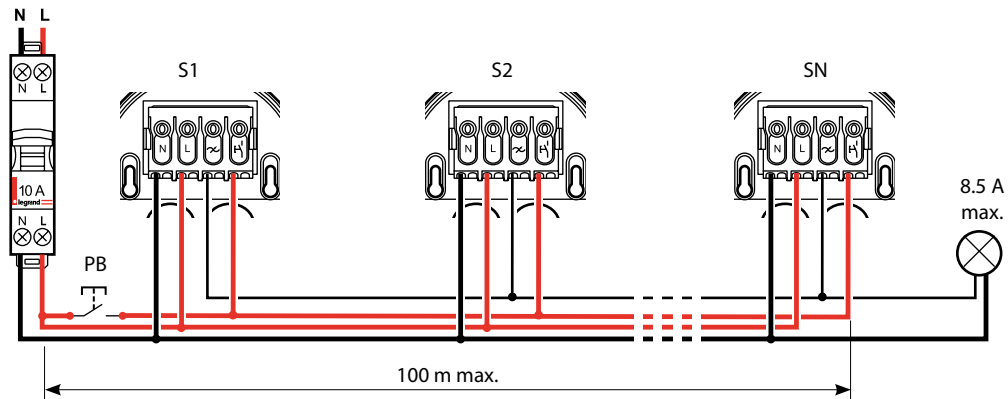

■ **4.4 Wiring with a timer**

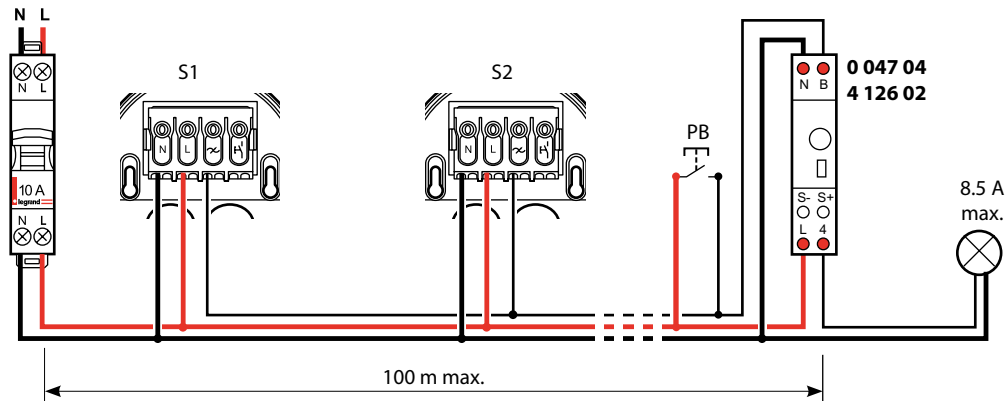

With this wiring, the configuration tool must be on "Pulse" (see paragraph 8. Settings).

5. REMOVAL

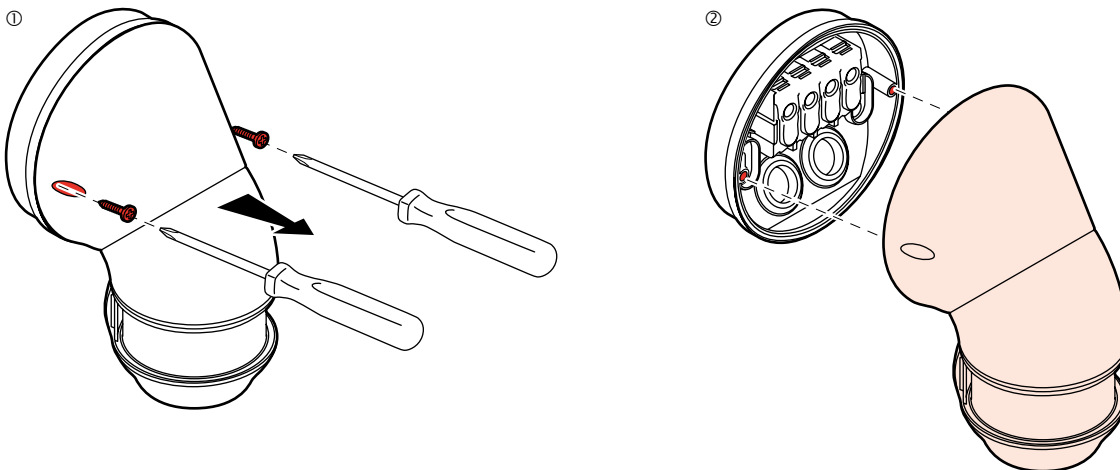

6. INSTALLATION

6.1 Sensor positioning

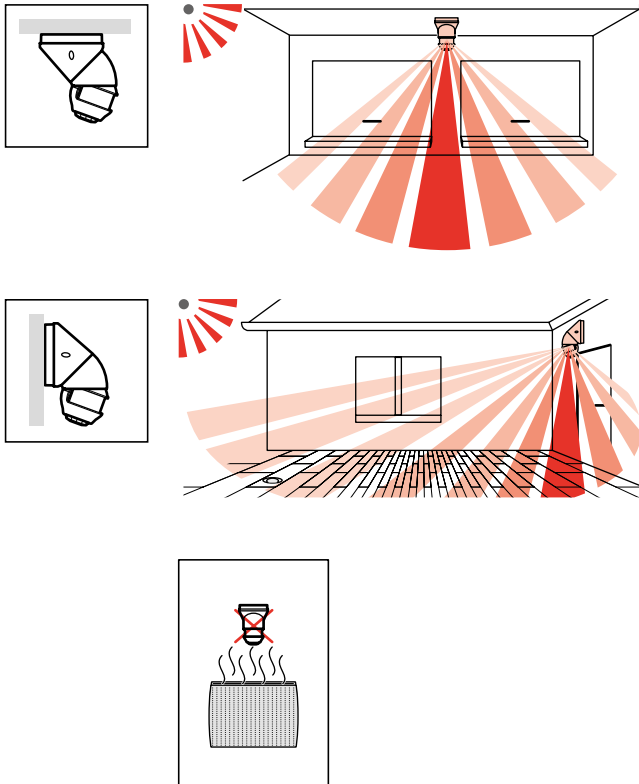

6.2 Recommended light exposure

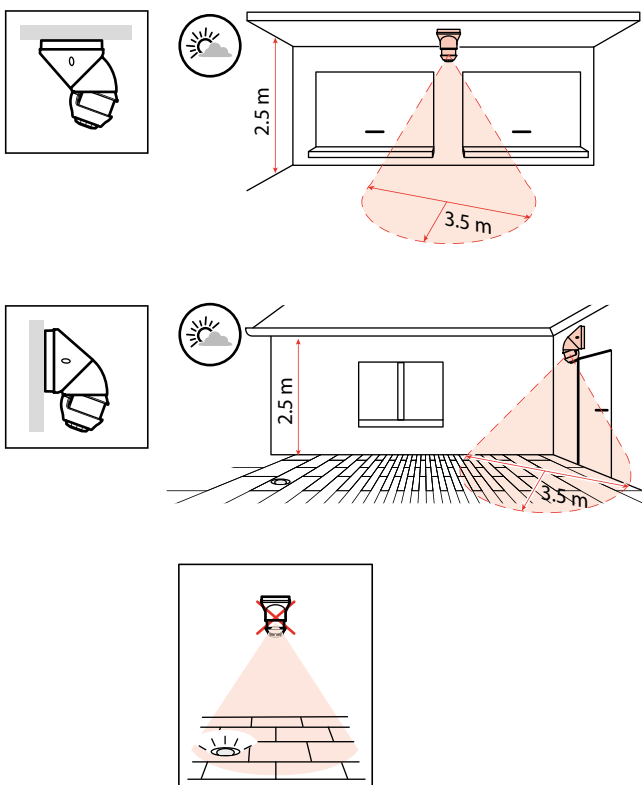

6. INSTALLATION (continued)

6.3 Fitting

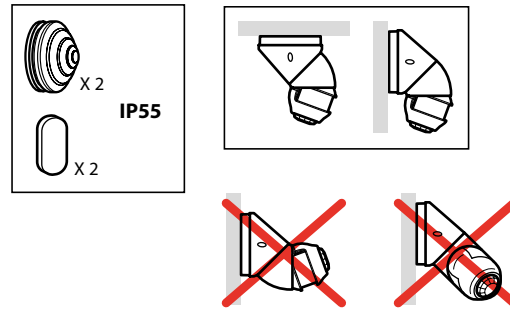

Attention:

Break the tabs to allow water to drain away.

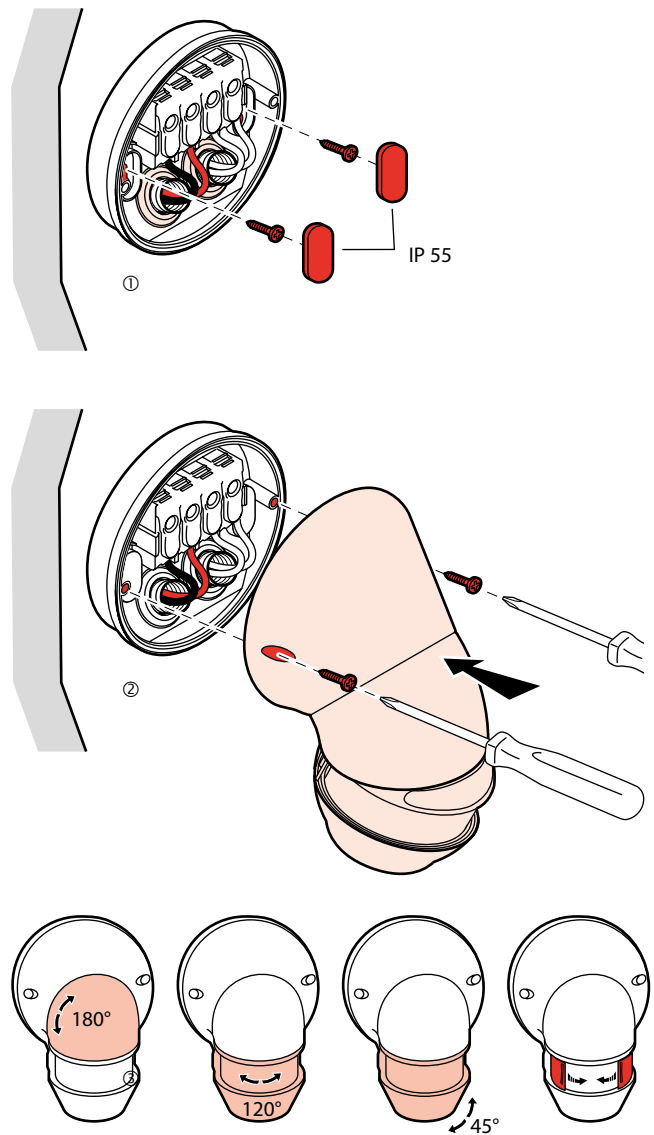
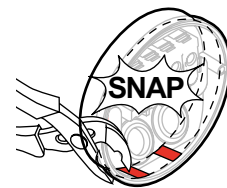

6. INSTALLATION (continued)

6.3 Fitting (continued)

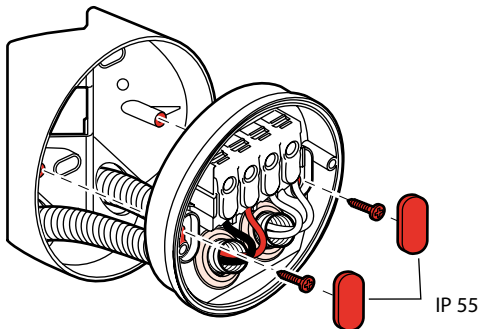
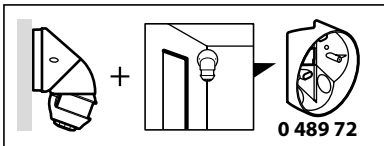
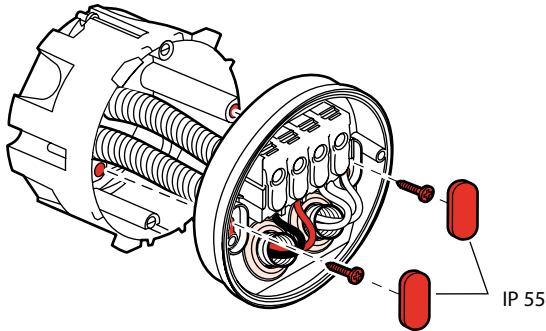
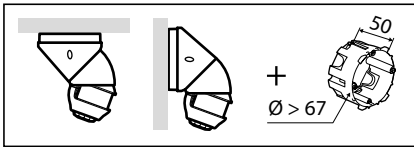

7. OPERATION

Manual ON/Auto OFF mode:

Pressing the auxiliary control allows the load to be switched on or off manually. If the control is not pressed, the sensor will cut off the load at the end of the time delay or when the light level threshold has been reached.

Auto ON/OFF mode:

The load will be switched on and off automatically.

Option: It is possible to manage the sensor using infrared remote control: Cat. Nos. 0 882 20/31.

7.1 More than one sensor and more than one load













































The products can be synchronised in two steps:

- one long press (>1s) all the sensors (S) switch to the ON state
- one short press all the sensors (S) inversion of OFF to ON or ON to OFF

<ul style="list-style-type: none"> ⊗ L1 OFF ⊗ L2 OFF ⊗ Ln OFF 	<ul style="list-style-type: none"> 💡 S1 OFF 💡 S2 OFF 💡 Sn OFF 	<p>PB</p> <p>< 1 s</p>	<ul style="list-style-type: none"> ☀ L1 ON ☀ L2 ON ☀ Ln ON 	<ul style="list-style-type: none"> 💡 S1 ON 💡 S2 ON 💡 Sn ON
<ul style="list-style-type: none"> ☀ L1 ON ☀ L2 ON ☀ Ln ON 	<ul style="list-style-type: none"> 💡 S1 ON 💡 S2 ON 💡 Sn ON 	<p>PB</p> <p>< 1 s</p>	<ul style="list-style-type: none"> ⊗ L1 OFF ⊗ L2 OFF ⊗ Ln OFF 	<ul style="list-style-type: none"> 💡 S1 OFF 💡 S2 OFF 💡 Sn OFF
<ul style="list-style-type: none"> ☀ L1 ON ⊗ L2 OFF ⊗ Ln OFF 	<ul style="list-style-type: none"> 💡 S1 ON 💡 S2 OFF 💡 Sn OFF 	<p>PB</p> <p>< 1 s</p>	<ul style="list-style-type: none"> ⊗ L1 OFF ☀ L2 ON ☀ Ln ON 	<ul style="list-style-type: none"> 💡 S1 OFF 💡 S2 ON 💡 Sn ON
<ul style="list-style-type: none"> ☀ L1 ON ⊗ L2 OFF ⊗ Ln OFF 	<ul style="list-style-type: none"> 💡 S1 ON 💡 S2 OFF 💡 Sn OFF 	<p>PB</p> <p>> 1 s</p>	<ul style="list-style-type: none"> ⊗ L1 OFF ⊗ L2 OFF ⊗ Ln OFF 	<ul style="list-style-type: none"> 💡 S1 OFF 💡 S2 OFF 💡 Sn OFF
<ul style="list-style-type: none"> ☀ L1 ON ⊗ L2 OFF ⊗ Ln OFF 	<ul style="list-style-type: none"> 💡 S1 ON 💡 S2 OFF 💡 Sn OFF 	<p>PB</p> <p>> 1 s</p>	<ul style="list-style-type: none"> ☀ L1 ON ☀ L2 ON ☀ Ln ON 	<ul style="list-style-type: none"> 💡 S1 ON 💡 S2 ON 💡 Sn ON

7. OPERATION (continued)

7.2 Several sensors connected to a single load

 L OFF	 S1 OFF  S2 OFF  Sn OFF	 < 1 s	 L ON	 S1 ON  S2 ON  Sn ON
 L ON	 S1 ON  S2 ON  Sn ON	 < 1 s	 L OFF	 S1 OFF  S2 OFF  Sn OFF
 L ON	 S1 ON  S2 OFF  Sn OFF	 < 1 s	 L ON	 S1 OFF  S2 ON  Sn ON
 L ON	 S1 ON  S2 OFF  Sn OFF	 > 1 s + < 1 s	 L OFF	 S1 OFF  S2 OFF  Sn OFF
 L ON	 S1 ON  S2 OFF  Sn OFF	 > 1 s	 L ON	 S1 ON  S2 ON  Sn ON

8. SETTINGS

8.1 Detection parameters

Sensor parameter	Default value	Modifiable parameters	Configuration tools	
			0 882 30	0 882 35
Time delay	15 min	3, 5, 10, 15, 20 min	-	✓
		5 s - 59 min 59 s	✓	-
Sensitivity	PIR (very high)	Low, medium, high, very high	✓	✓
Modes	Auto on/Auto off	Inactive	Activate/Deactivate	✓
	Walk-through mode	Active	Activate/Deactivate	✓
	Manual on/Auto off	Inactive	Activate/Deactivate	✓
Detection system	Initial	PIR	Not modifiable	✓
	Maintain	PIR	Not modifiable	✓
	Restart	PIR	PIR, Deactivate	✓
Alarm	Inactive	Activate/Deactivate	✓	-

 **Time delay:** Length of time the load is on after detection occurs.

 **Sensitivity:** Detection range setting.

 **Pulse function:** Value 0 (on configuration tool 0 882 30) is used to set the time delay on the timer.

For timer operation, activate the pulse function with the configuration tool 0 882 30. Go to Sensor parameter\time delay, then set the time delay to 00 h 00 min 00 s: the Pulse icon appears on the screen, then send the setting to the sensor and the PULSE function will be activated, finally set the time delay on the timer (10 minutes max).

Modes:

Auto on/Auto off mode:

Comes on automatically:

- At the detection of a presence if there is an insufficient natural level of light.

Turns off automatically:

- If no presence is detected and at the end of the time delay set.

- Or if the natural light level is sufficient (regulation activated).

Any new detection triggers an automatic switch-on if there is insufficient light.

Walk-through mode:

- If no presence is detected in the 20 seconds following an initial detection, the product will cut off the load after 3 minutes.

- If another presence is detected in the 3 minutes following initial detection, the device will cut off the load at the end of the set time delay.

Manual on/Auto off mode:

Manual switch-on, automatic switch-off:

- When no presence is detected and at the end of the set time delay.

After switch-off, any new detection within a 30-second period triggers an automatic switch-on. The Restart function must be activated.

After 30 seconds the device is switched on via a manual control.

Detection system:

Initial detection: The load is switched on as soon as the first detection occurs if the natural light level is below the light level threshold.

Maintain: The load remains active if another presence is detected.

Restart: In manual mode. After switch-off, any new detection within a 30-second period triggers an automatic switch-on.

After 30 seconds the device must be switched on manually.

Alarm: an audible signal is emitted before switch-off (1 minute before, then 30 seconds, then 10 seconds).

8. SETTINGS (continued)

8.2 Light parameters

Sensor parameter	Default value	Modifiable parameters	Configuration tools	
			0 882 30	0 882 35
Light level threshold	150 lux	20, 100, 300, 500, 1000 lux	–	✓
		5 - 1275 lux	✓	–
Advanced mode	Calibration	–	✓	–
	Regulation	Active	✓	–
	Light contribution	Auto	✓	–

 **Light level threshold:** Value at which the load comes on if the natural light level is less than the setting.

 **Eye function:** Value 0 (eye on configuration tool 0 882 30) is used to save the ambient light level in the room as a light level threshold.

Advanced mode:

 **Calibration:** The ambient light level measured with a luxmeter must then be transmitted to the sensor (see data sheet Cat. No. 0 882 30).

 **Regulation:** Automatic switch-off of the load 10 minutes after the light level threshold is exceeded with an additional safety threshold (to avoid lights switching off at the wrong moment).

Light contribution: Quantity of additional lux brought in by the load being switched on.

When the light contribution parameter is set to "Auto" (value 0) on configuration tool 0 882 30, the sensor automatically calculates the light contribution.

8.3 Modifying the parameters using the configuration tools

• 0 882 40: Configuration gateway and Legrand Close Up application. The Close Up application is available on the Apple Store and the Play Store



App Store



Google Play



The detector functions are controlled by a number of parameters which can be changed or programmed by an infrared configurator. In combination with configuration tool 0 882 40, the Legrand Close Up smartphone app can be used to view and modify all the detector parameters with online help.

Point the infrared configuration tool at the detector and send the necessary programming commands to the unit as indicated in the table below.

For more information about setting parameters, refer to the data sheet for the configuration gateway Cat. No. 0 882 40.

8. SETTINGS (continued)

8.3 Modifying the parameters using the configuration tools (suite)

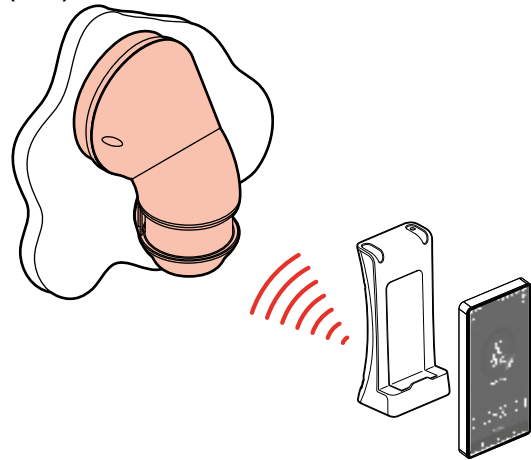

• 0 882 35: Simplified configuration tool

• 0 882 30: Advanced configuration tool

When the sensor receives an IR command via a configuration tool, it emits a beep acknowledging the modification.

For more information about setting parameters, refer to the data sheet for the configuration tool Cat. No. 0 882 30 and the lighting management sensor guide.

- Restore to factory settings:

1st press: Short press on LEARN, the LED flashes slowly.

2nd press: Hold down LEARN for 10 seconds until the LED flashes quickly.

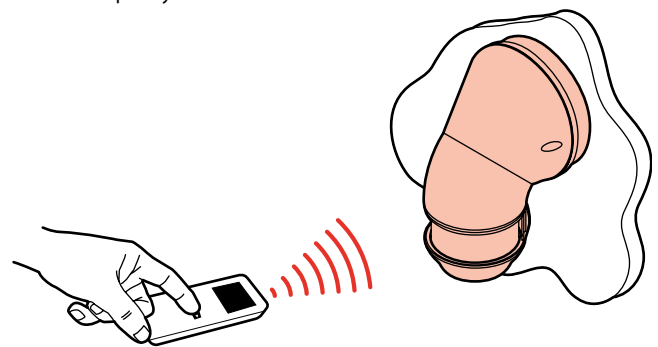

As from 01/01/2022, this product ref. 0 882 30 is no longer sold.

9. PERFORMANCE

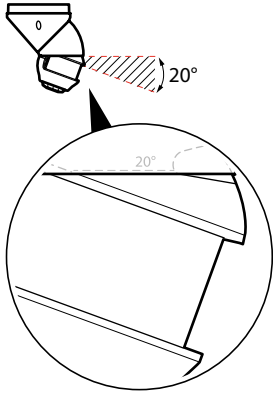

9.1 Radial movement

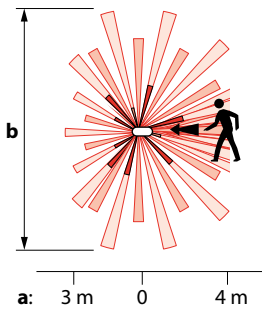
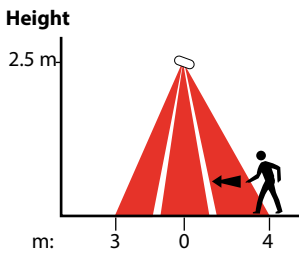

Installation height: 2.5 m and 4 m

	Sensitivity Low (25%)		Sensitivity Medium (50%)		Sensitivity High (75%)		Sensitivity Very high (100%)	
	a (m)	b (m)	a (m)	b (m)	a (m)	b (m)	a (m)	b (m)
2.5	2	6	3	6	4	6	4	6
4	2	7	3	7	4	8	4	8

9. PERFORMANCE (continued)

9.2 Tangential movement

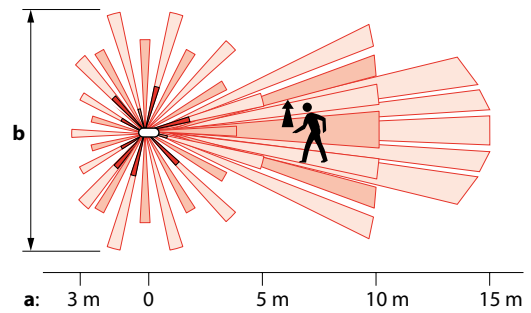
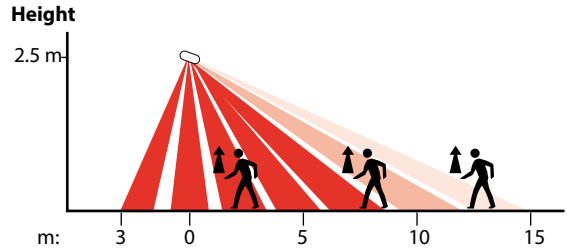

Installation height: 2.5 m and 4 m

	Sensitivity Low (25%)		Sensitivity Medium (50%)		Sensitivity High (75%)		Sensitivity Very high (100%)	
	a (m)	b (m)	a (m)	b (m)	a (m)	b (m)	a (m)	b (m)
2.5	8	6	10	7	11	8	15	10
4	9	7	11	8	14	9	18	10

10. CARE

Keep the lens clean.

Clean the surface with a cloth.

Do not use: acetone, tar-removing cleaning agents or trichloroethylene.

Resistant to the following products: - Hexane (En 60669-1)

- Methylated spirit
- Soapy water
- Diluted ammonia
- Bleach diluted to 10%
- Window-cleaning products

Attention:

Always test before using other special cleaning products.

12. STANDARDS

Directive: CE

Installation standard: NFC 15-100

Product standards: IEC 60669-2-1

Environmental standards:

- European Directive 2002/96/EC: WEEE (Waste Electrical and Electronic Equipment).
- European Directive 2002/95/EC: RoHS (Restriction of Hazardous Substances).
- Regulations: ERP (public buildings)
ERT (workplace buildings)
IGH (high-rise buildings)

Note:

All technical information is available at

11. TROUBLESHOOTING

PROBLEM	CAUSES	SOLUTIONS
Lighting stays on when there is no-one present	Some sources of interference, such as air currents, vibrations and radiators, can cause unintended operation	1- Reduce the sensitivity level 2- If the interference continues: using the configuration tool, go into the Detection system parameters, select Maintain and then choose PIR 3- If the interference still continues, move the sensor away from sources of interference
Lighting does not switch off during the day when there is an adequate level of natural light	Regulation function not active Light level threshold set too high Light contribution is too high	Activate the regulation function Reduce the light level threshold Check that the sensor is positioned correctly in relation to the window Decrease the power of the luminaires
Lighting switches off when there are people present and the natural light level is not adequate (darkness)	Time delay too short Detection sensitivity too low Light level threshold too low	Increase the time delay For work areas, choose between 10 and 1 (10 minutes recommended) Increase the sensitivity Move the sensor closer to the work area Increase the threshold