

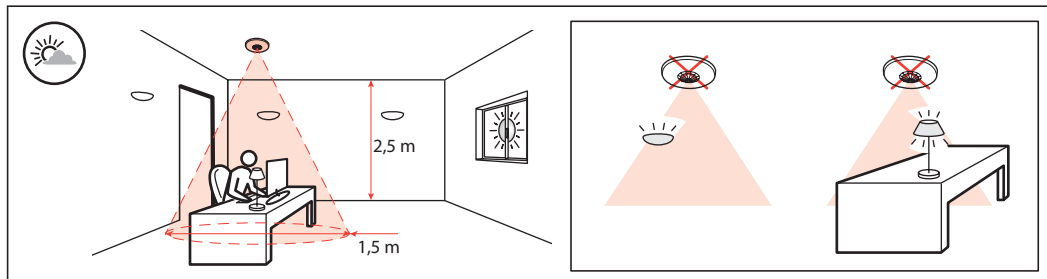

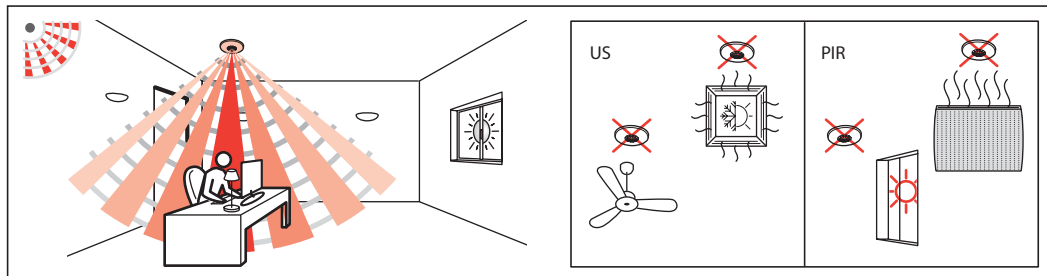

	12-20 V DALI
	25 mA
	RJ45
	-5°C → +45°C
	PIR / ULTRASONIC
	500 lux
	15 mn
	Auto ON/OFF
	Ø 8 m

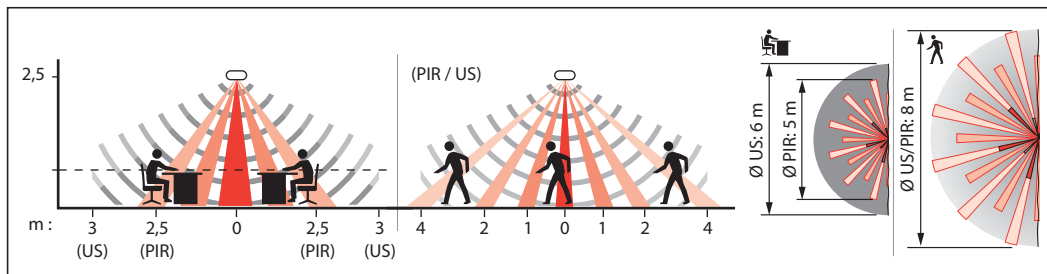

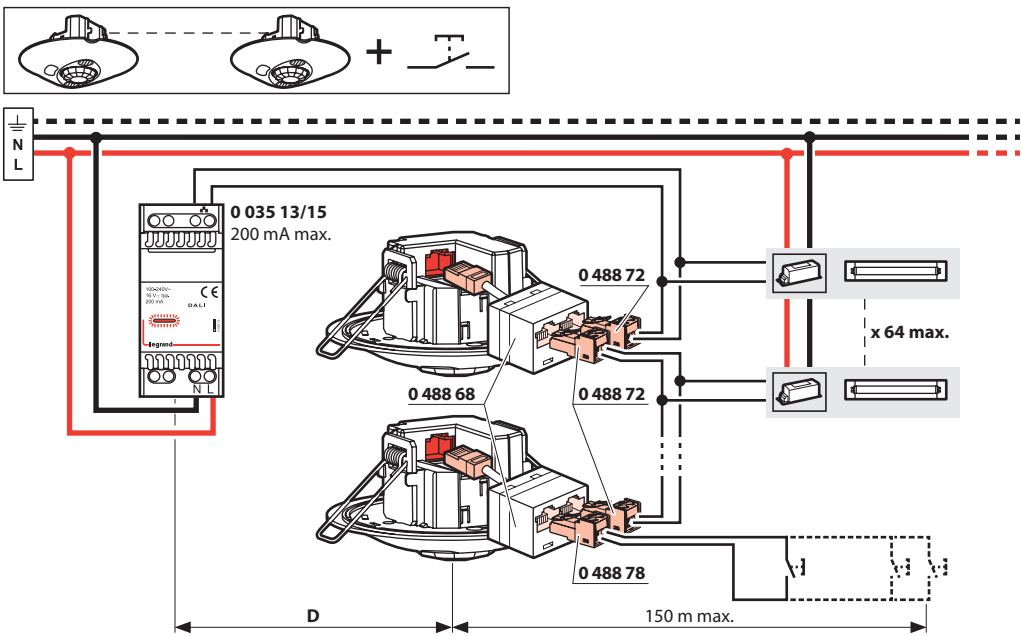
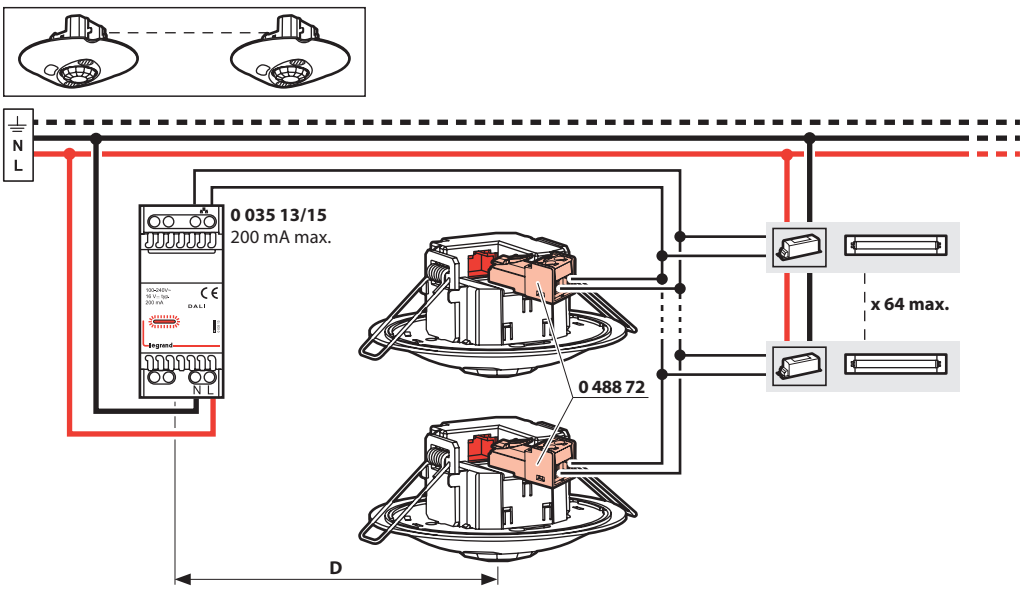



D	
≤ 100 m	0,5 mm ²
≤ 150 m	0,75 mm ²
≤ 300 m	1,5 mm ²

 • Le poussoir est obligatoirement connecté à un détecteur maître à l'aide de la Réf. **0 488 78**.

 +  • Push button must be connected to a master detector through **Cat. No. 0 488 78**.

 → 25 mA

 → 2 mA

Test

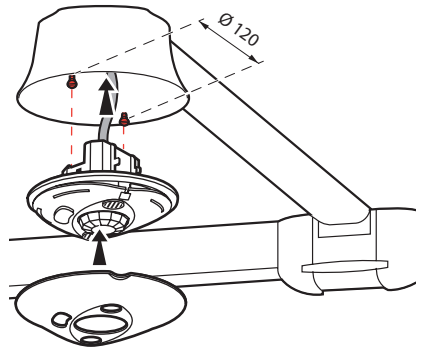
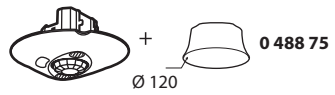
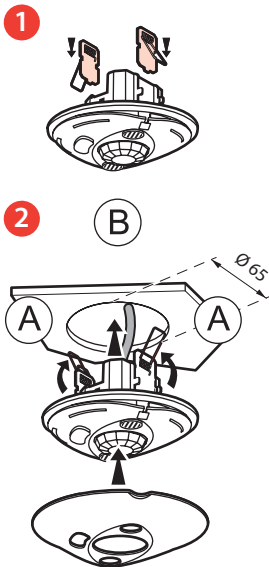
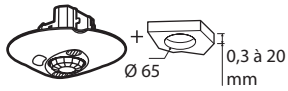
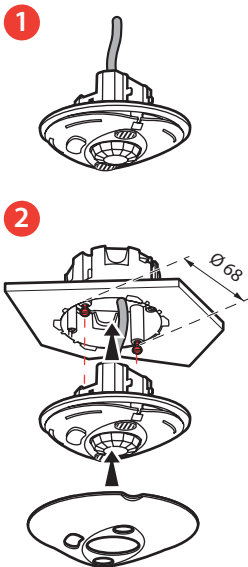
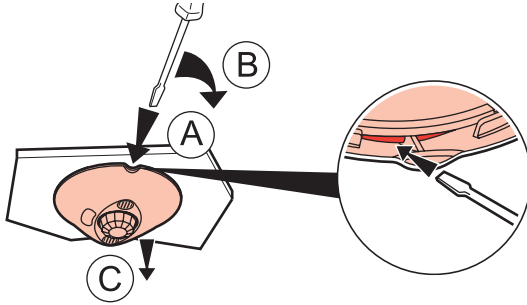
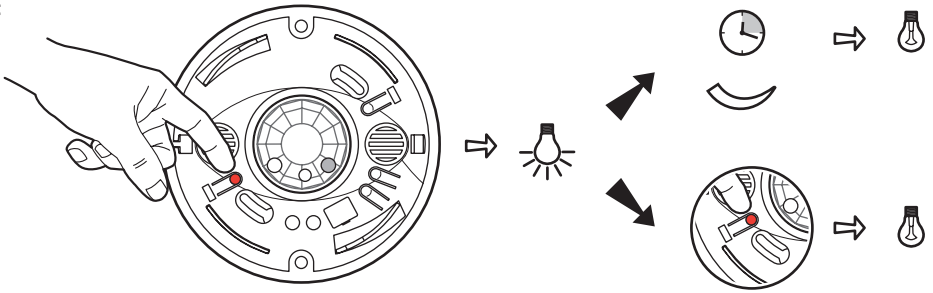



Auto ON/OFF



Manual ON / Auto OFF



i www.legrandoc.com

	5 - 1275 lux
	5 sec - 2 h
	25% - 50% - 75% - 100%
Mode	Auto ON/OFF - Manual On/Auto OFF - Walkthrough

- Capteur US
- US sensor

- LED de détection
- Motion LED

- Bouton de TEST
- TEST button

- LED Rouge Configuration DALI
- DALI Configuration RED LED

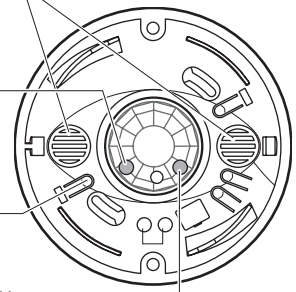

* 0 882 30
BMSO4001

* Version minimum du firmware **3.0.0**, mise à jour disponible sur www.legrandoc.com
 * Minimum version of **3.0.0** firmware update available on www.legrandoc.com