

# FEED-IN for SLV 3-CIRCUIT SURFACE MOUNTED TRACK

art.-no. 1001378 175040/44 1001379 175050/54

220V-250V  
~50Hz

16A  
max.



1001375 175010/14  
1001376 175020/24  
1001377 175030/34

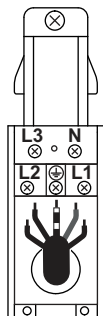
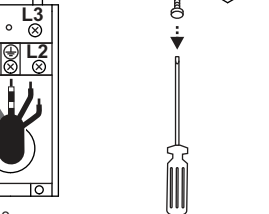
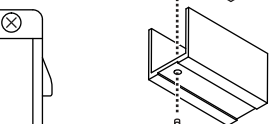
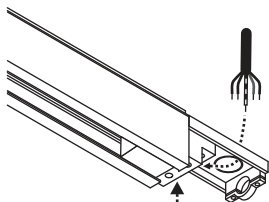
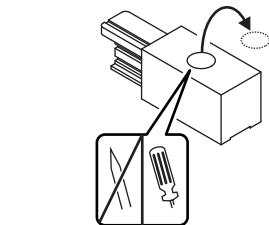
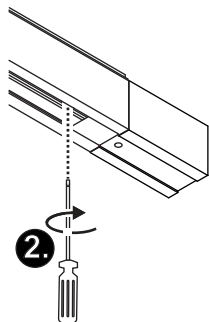
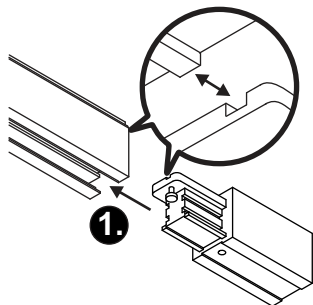

art.-no.  
1001378 175040/44

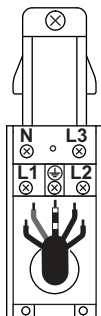

art.-no.  
1001379 175050/54