

BTAL405D

NOISE TELEVISION
Nuit

ALTEGE™

belgino

legrand®

Pro & Consumer Service
BP 30076 - 87002 LIMOGES CEDEX FRANCE
www.legrand.fr

Design & Quality by LEGRAND (France)

Pour fiche TV 9,52 mm
Compatible qualité UHD (4K)
Blindage Class A (4G protégé)
Atténuation < 1 dB

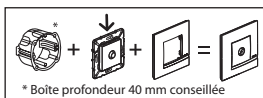

Griffes vendues séparément (Réf. BTAL0001)*

* En rénovation : pour fixation du mécanisme dans une boîte sans vis

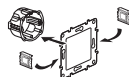

Télévision



Fixation
à vis

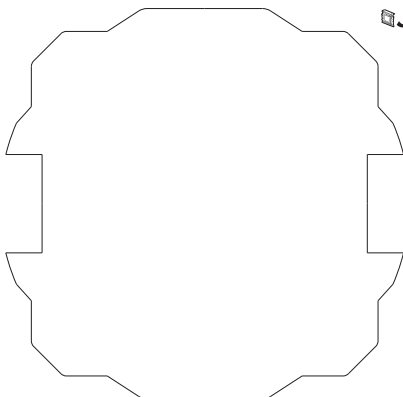

PENSEZ AU TRI !

film plastique à jeter

feuille carton à recycler

CONSOMMEUR POUVANT VARIER LOCALEMENT > WWW.CONSOMMESCREDITIER.FR

Schéma de câblage
à l'intérieur

Made in France

2 ans
GARANTIE



 Respecter strictement les conditions d'installation et d'utilisation.

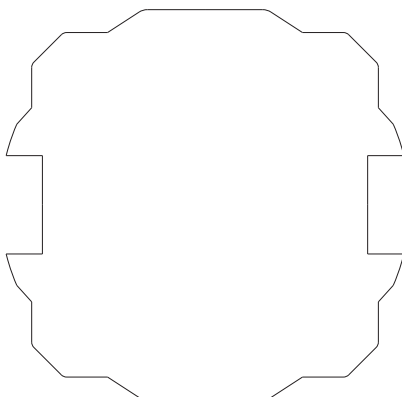

LED0974AA

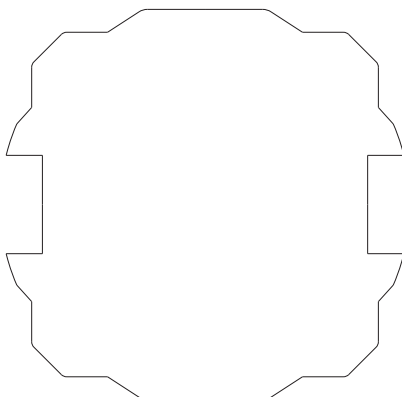
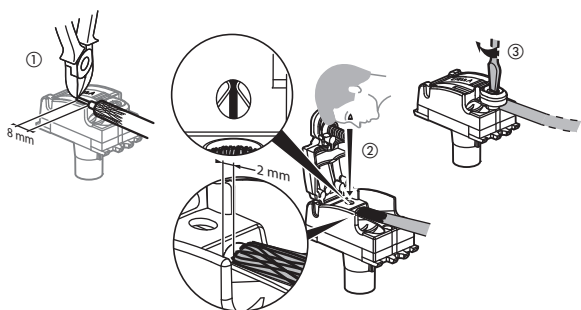
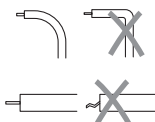
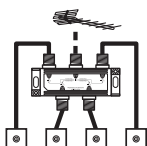

Utiliser un câble coaxial
Ø 5,5 à 7 mm - 75 Ω

