



Principales

Gamme de produit	Relais de temporisation Harmony
Type de produit ou équipement	Relais multifonctions
Type de sortie logique	Relais
Largeur	17,5 mm
Nom de l'appareil	RE17R
Type de temporisation	Puissance d'enclenchement Enclenchement et déclenchement Intervalle Durée d'inhibition Clignotement asymétrique
Plage de temporisation	6...60 min 1...10 H 0,1...1 s 1...10 s 1...10 min 10...100 H 6...60 s
Courant de sortie nominal	8 A

Complémentaires

Description des contacts	1 F/O
Matière des contacts	Sans cadmium
Hauteur	90 mm
Profondeur	72 mm
Type de commande	Sélecteur face avant
[Us] tension d'alimentation	24...240 V CA 50/60 Hz 24 V CC
Plage d'utilisation en tension	0,85 à 1,1 Us
Fréquence d'alimentation	50...60 Hz +/- 5 %
Libération de la tension d'entrée	10 V
Mode de raccordement	Bornes à vis, 1 x 0,5 à 1 x 3,3 mm ² (AWG 20 à AWG 12) rigide sans embout Bornes à vis, 2 x 0,5 à 2 x 2,5 mm ² (AWG 20 à AWG 14) rigide sans embout Bornes à vis, 1 x 0,2 à 1 x 2,5 mm ² (AWG 24...AWG 14) souple avec embout Bornes à vis, 2 x 0,2 à 2 x 1,5 mm ² (AWG 24 à AWG 16) souple avec embout
Couple de serrage	0,6...1 N.m se conformer à CEI 60947-1
Matière du boîtier	Auto-extinguible
Précision de répétition	+/- 0,5% se conformer à CEI 61812-1
Dérive en température	+/- 0,05 %/°C
Dérive en tension	+/- 0,2 %/V
Réglage exact du temps de retard	+/- 10 % pleine échelle à 25 °C se conformer à CEI 61812-1
Largeur d'impulsion du signal de commande	100 ms avec charge en parallèle typique 30 ms typique
Résistance d'isolement	100 MΩ à 500 V CC se conformer à CEI 60664-1
Temps de reset	120 ms sur désexcitation typique
Facteur de marche	100 %
Puissance consommée en VA	0...32 VA à 240 V CA
Puissance consommée maximale en W	0,6 W à 24 V CC
Courant commuté minimum	10 mA à 5 V CC
Courant commuté maximum	8 A CA/CC

Tension de coupure maximale	250 V CA
Pouvoir de coupure	2000 VA
Fréquence de fonctionnement	10 Hz
Durée de vie électrique	100000 cycle pour résistive charge (8 A à 250 V CA maximum)
Endurance mécanique	10000000 cycle
Tenue diélectrique	2,5 kV 1 mA/1 minute 50 Hz se conformer à CEI 61812-1
[Uimp] tension assignée de tenue aux chocs	5 kV pendant 1,2/50 µs
Délai de mise sous tension	100 ms
Marquage	CE
Distance de fuite	4 kV/3 se conformer à CEI 60664-1
Données de fiabilité de la sécurité	B10d = 270000 MTTFd = 296,8 années
Position de montage	Toutes positions par rapport au plan de montage vertical normal
Support de montage	Rail DIN 35 mm se conformer à EN/CEI 60715
Signalisation locale	Voyant DEL pour stabilisé: relais alimenté, aucune temporisation en cours Voyant DEL 80 % MARCHE et 20 % ARRET pour clignotant: temporisation en cours Voyant DEL 5 % MARCHE et 95 % ARRET pour impulsion: relais hors tension, pas de chrono en cours (sauf fonct Di-D, Li-L)
Poids du produit	0,07 kg
Type de temporisation	A, Ac, At, B, Bw, C, D, Di, H, Ht
Fonctionnalité	Multifonction
Code de compatibilité	RE17

Environnement

Immunité aux micro-coupures	20 ms
Normes	2006/95/EC 2004/108/EC CEI 61812-1 EN 61000-6-2 EN 61000-6-3 EN 61000-6-4 EN 61000-6-1
Certifications du produit	CSA GL cULus
Température ambiante de stockage	-30...60 °C
Température ambiante de fonctionnement	-20...60 °C
Degré de protection IP	IP20 se conformer à CEI 60529 (bornier) IP40 se conformer à CEI 60529 (enveloppe) IP50 se conformer à CEI 60529 (face avant)
Tenue aux vibrations	20 m/s ² (f= 10...150 Hz) se conformer à CEI 60068-2-6
Tenue aux chocs mécaniques	15 gn pour 11 ms se conformer à CEI 60068-2-27
Humidité relative	93 % sans condensation se conformer à CEI 60068-2-30
Compatibilité électromagnétique	Test d'immunité aux décharges électrostatiques: (en contact) ,niveau 3,6 kV se conformer à CEI 6100-4-11 Test d'immunité aux décharges électrostatiques: (dans l'air) ,niveau 3,8 kV se conformer à CEI 6100-4-11 Perturbation liée aux champs électromagnétiques: (80 MHz à 1 GHz) ,niveau 3,10 V/m se conformer à CEI 61000-4-3 Test d'immunité aux transitoires électriques rapides: (clip de connexion capacitive) ,niveau 3,1 kV se conformer à CEI 61000-4-4 Test d'immunité aux transitoires électriques rapides: (directe) ,niveau 3,2 kV se conformer à CEI 61000-4-4 Test d'immunité aux ondes de choc 1,2/50 µs: (mode différentiel) ,niveau 3,1 kV se conformer à CEI 61000-4-5 Test d'immunité aux ondes de choc 1,2/50 µs: (mode commun) ,niveau 3,2 kV se conformer à CEI 61000-4-5 Perturbations RF transmises par conduction: (0,15 à 80 MHz) ,niveau 3,10 V se conformer à CEI 61000-4-6 Test d'immunité aux baisses et aux interruptions de tension: (1 cycle) ,0 % se conformer à CEI 61000-4-11 Test d'immunité aux baisses et aux interruptions de tension: (25/30 cycles) ,70 % se conformer à CEI 61000-4-11 Émissions transmises par conduction et rayonnées: ,classe B se conformer à EN 55022

Emballage

Type d'emballage 1	PCE
Nb produits dans l'emballage 1	1
Hauteur de l'emballage 1	2,600 cm
Largeur de l'emballage 1	7,800 cm
Longueur de l'emballage 1	9,500 cm
Poids de l'emballage 1	80,000 g
Type d'emballage 2	S02
Nb produits dans l'emballage 2	40
Hauteur de l'emballage 2	15,000 cm
Largeur de l'emballage 2	30,000 cm
Longueur de l'emballage 2	40,000 cm
Poids de l'emballage 2	3,690 kg
Type d'emballage 3	P06
Nb produits dans l'emballage 3	640
Hauteur de l'emballage 3	75,000 cm
Largeur de l'emballage 3	60,000 cm
Longueur de l'emballage 3	80,000 cm
Poids de l'emballage 3	65,700 kg

Durabilité de l'offre

Statut environnemental de l'offre	Produit Green Premium
Régulation REACH	Déclaration REACH
Directive RoHS UE	Conformité pro-active (Produit en dehors du scope légal RoHS UE) Déclaration RoHS UE
Sans mercure	Oui
Régulation RoHS Chine	Déclaration RoHS Pour La Chine
Information sur les exemptions RoHS	Oui
Profil environnemental	Profil Environnemental Du Produit
Profil de circularité	Informations De Fin De Vie

Garantie contractuelle

Garantie	18 mois
----------	---------

Width 17.5 mm

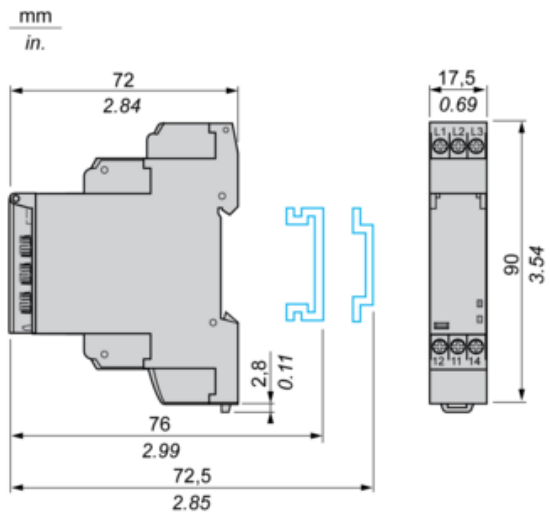

Internal Wiring Diagram

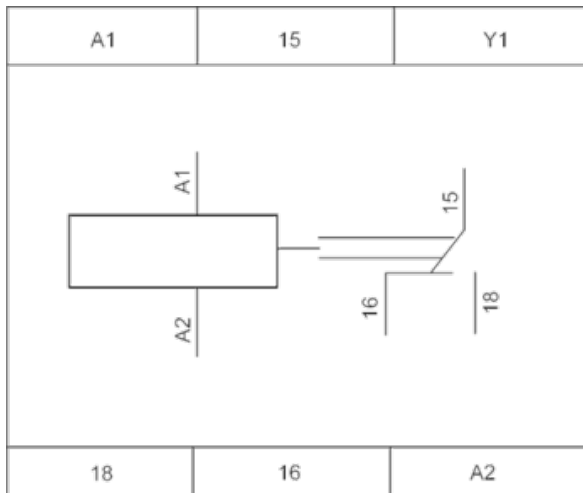

Wiring Diagram

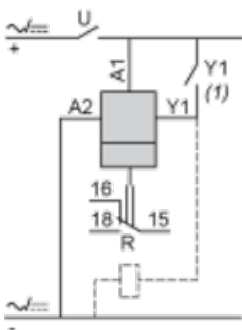

1) Contact Y1:

- Control for functions B, C, Ac, Bw, Ad, Ah, N, O, W, T, Tt.
- Partial stop for functions At, Ht and Pt.
- Function D if Di selected.
- Not used for functions A, H and P.

Function A : Power on Delay Relay

Description

The timing period T begins on energisation. After timing, the output(s) R close(s). The second output can be either timed or instantaneous.

Function: 1 Output



Function: 2 Outputs

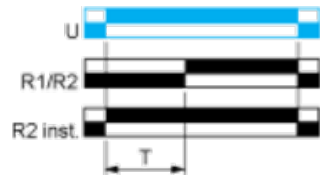

2 timed outputs (R1/R2) or 1 timed output (R1) and 1 instantaneous output (R2 inst.)

Function Ac: On-Delay & Off-Delay with Control Signal

Description

After energisation of power supply and energization of Y1 causes the timing period T to start.

At the end of this timing period, the output(s) R close(s).

When deenergization of Y1, the timing T starts.

At the end of this timing period T, the output(s) R revert(s) to its/their initial position.

The second output (R2) can be either timed (when set to "TIMED") or instantaneous (when set to "INST").

Function: 1 Output

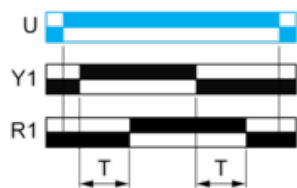

Function: 2 Outputs

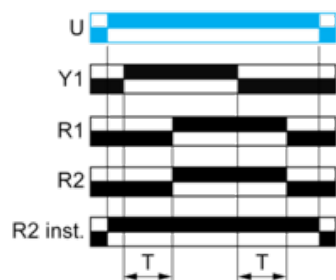

Function At : Power on Delay Relay (Summation) with Control Signal

Description

After power-up, the first opening of control contact C starts the timing. Timing can be interrupted each time control contact closes. When the cumulative total of time periods elapsed reaches the pre-set value T, the output relay closes.

Function: 1 Output

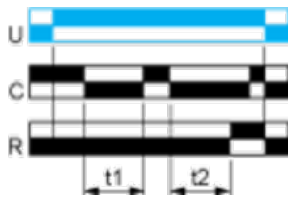

$$T = t1 + t2 + \dots$$

Function B : Interval Relay with Control Signal

Description

After power-up, pulsing or maintaining control contact C starts the timing T. The output R closes for the duration of the timing period T then reverts to its initial state.

Function: 1 Output

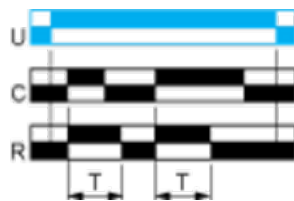

Function Bw : Double Interval Relay with Control Signal

Description

On closing and opening of control contact C, the output R closes for the duration of the timing period T.

Function: 1 Output



Function C : Off-Delay Relay with Control Signal

Description

After power-up and closing of the control contact C, the output R closes. When control contact C re-opens, timing T starts. At the end of the timing period, the output(s) R revert(s) to its/their initial state. The second output can be either timed or instantaneous.

Function: 1 Output

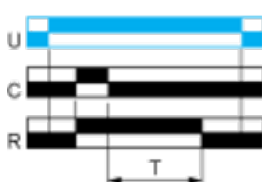

Function: 2 Outputs

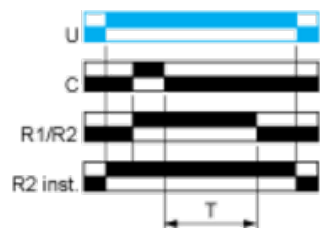

2 timed outputs (R1/R2) or 1 timed output (R1) and 1 instantaneous output (R2 inst.)

Function D: Symmetrical Flashing Relay (Starting Pulse Off)

Description

On energisation of power supply, output(s) R starts at its/their initial state for timing duration T then change(s) to output(s) R close(s) for the same timing duration T. This cycle is repeated indefinitely until power supply removal. Specially for RE17*, RE22R2AMU, RE22R2MMW, RE22R2MMU, RE22R2MJU, this D function can only be initiated by energizing Y1 permanently. The second output (R2) can be either timed (when set to "TIMED") or instantaneous (when set to "INST").

Function: 1 Output

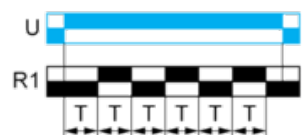

Function: 2 Outputs

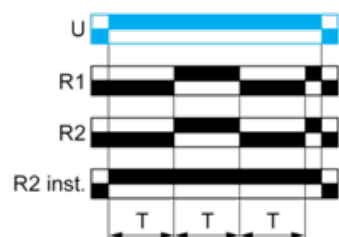

Function: 1 Output with Retrigger / Restart Control

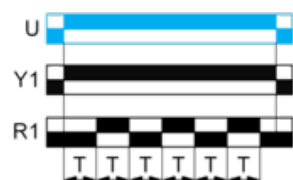

Function: 2 Output with Retrigger / Restart Control

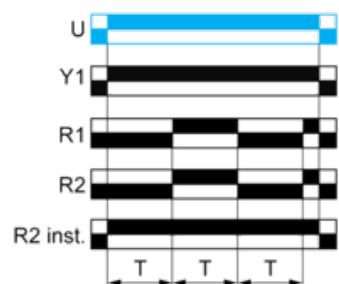

Function Di : Symmetrical Flasher Relay (Starting Pulse On)

Description

Repetitive cycle with two timing periods T of equal duration, with output(s) R changing state at the end of each timing period T. The second output can be either timed or instantaneous.

Function: 1 Output



Function: 2 Outputs

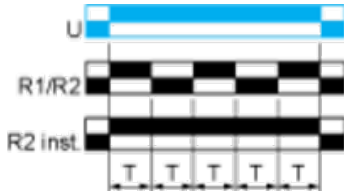

2 timed outputs (R1/R2) or 1 timed output (R1) and 1 instantaneous output (R2 inst.)

Function H : Interval Relay

Description

On energisation of the relay, timing period T starts and the output(s) R close(s). At the end of the timing period T, the output(s) R revert(s) to its/their initial state. The second output can be either timed or instantaneous.

Function: 1 Output



Function: 2 Outputs

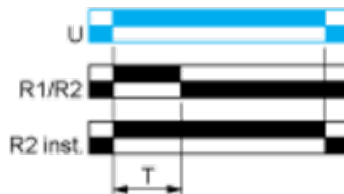

2 timed outputs (R1/R2) or 1 timed output (R1) and 1 instantaneous output (R2 inst.)

Function Ht: Interval Relay & With Pause / Summation Control

Description

On energisation of power supply, output(s) R close(s) and timing period T starts.

The timing can be interrupted / paused each time X1 energizes.

When the cumulative total of time periods elapsed reaches the pre-set value T, the output(s) R revert(s) to its/their initial state. Reenergization of X1 will also cause output(s) R close(s) if the time has elapsed and restart the same operation as described at the beginning.

Except for RE17*, RE22R2MMW, RENF22R2MMW, RE22R2MMU and RE22R2MJU, timing can be interrupted / paused each time Y1 energizes.

The second output (R2) can be either timed (when set to "TIMED" or instantaneous (when set to "INST").

Function: 1 Output

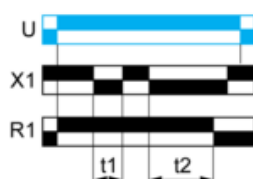

$T = t_1 + t_2 + \dots$

Function: 2 Outputs

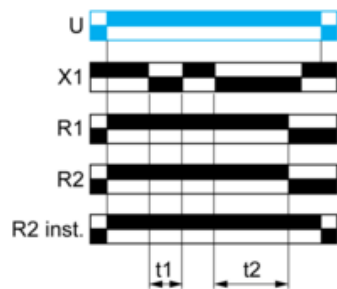

$T = t_1 + t_2 + \dots$

Function: 1 Output with Retrigger / Restart Control

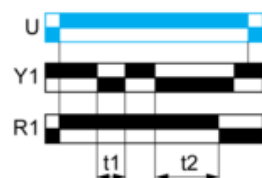

$T = t_1 + t_2 + \dots$

Function: 2 Outputs with Retrigger / Restart Control

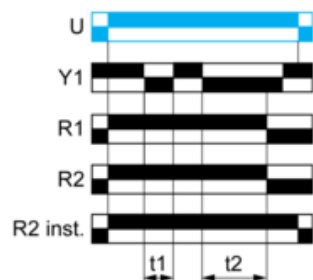

$T = t_1 + t_2 + \dots$

Legend

Relay de-energised

Relay energised

Output open

Output closed

C	Control contact
G	Gate
R	Relay or solid state output
R1/R2	2 timed outputs
R2 inst.	The second output is instantaneous if the right position is selected
T	Timing period
Ta -	Adjustable On-delay
Tr -	Adjustable Off-delay
U	Supply