

PowerLogic

HeatTag Wireless Sensor for Early Detection of Overheating Cables

User Guide

PowerLogic offers power quality, uptime and efficiency.

DOCA0171EN-00
01/2021



Legal Information

The Schneider Electric brand and any trademarks of Schneider Electric SE and its subsidiaries referred to in this guide are the property of Schneider Electric SE or its subsidiaries. All other brands may be trademarks of their respective owners.

This guide and its content are protected under applicable copyright laws and furnished for informational use only. No part of this guide may be reproduced or transmitted in any form or by any means (electronic, mechanical, photocopying, recording, or otherwise), for any purpose, without the prior written permission of Schneider Electric.

Schneider Electric does not grant any right or license for commercial use of the guide or its content, except for a non-exclusive and personal license to consult it on an "as is" basis. Schneider Electric products and equipment should be installed, operated, serviced, and maintained only by qualified personnel.

As standards, specifications, and designs change from time to time, information contained in this guide may be subject to change without notice.

To the extent permitted by applicable law, no responsibility or liability is assumed by Schneider Electric and its subsidiaries for any errors or omissions in the informational content of this material or consequences arising out of or resulting from the use of the information contained herein.

Table of Contents

Safety Information.....	5
About the Book.....	6
Presentation.....	7
PowerLogic Master Range	7
HeatTag Description	8
Hardware Description	10
Technical Characteristics	12
Schneider Electric Green Premium™ Ecolabel	14
Use	16
Commissioning	16
Manual Pairing of the HeatTag Sensor to a Panel Server or Gateway	16
Unpairing the HeatTag Sensor	16
Acknowledging an Alert.....	17
Resetting the HeatTag Sensor to Factory Settings.....	17
Test With the HeatTag Tester	18
Remote Use of Data	22
Troubleshooting	23
Appendices	24
HeatTag Tester Liquid - Safety Data Sheet.....	25

Safety Information

Important Information

Read these instructions carefully and look at the equipment to become familiar with the device before trying to install, operate, service, or maintain it. The following special messages may appear throughout this documentation or on the equipment to warn of potential hazards or to call attention to information that clarifies or simplifies a procedure.



The addition of this symbol to a “Danger” or “Warning” safety message indicates that an electrical hazard exists which will result in death or serious injury if the instructions are not followed.



This is the safety alert symbol. It is used to alert you to potential personal injury hazards. Obey all safety messages with this symbol to avoid possible injury or death.

⚠ DANGER
DANGER indicates a hazardous situation which, if not avoided, will result in death or serious injury.
Failure to follow these instructions will result in death or serious injury.

⚠ WARNING
WARNING indicates a hazardous situation which, if not avoided, could result in death or serious injury.
Failure to follow these instructions can result in death, serious injury, or equipment damage.

⚠ CAUTION
CAUTION indicates a hazardous situation which, if not avoided, could result in minor or moderate injury.
Failure to follow these instructions can result in injury or equipment damage.

NOTICE
NOTICE is used to address practices not related to physical injury. The safety alert symbol shall not be used with this signal word.
Failure to follow these instructions can result in equipment damage.

Please Note

Electrical equipment should be installed, operated, serviced, and maintained only by qualified personnel. No responsibility is assumed by Schneider Electric for any consequences arising out of the use of this material.

A qualified person is one who has skills and knowledge related to the construction, installation, and operation of electrical equipment and its installation and has received safety training to recognize and avoid the hazards involved.

About the Book

Document Scope

This document provides users with the technical information needed to operate PowerLogic™ HeatTag™ wireless sensors for early detection of overheating cables.

Validity Note

This document applies to HeatTag sensors with firmware version 002.002.005 or greater.

Online Information

The information contained in this guide is likely to be updated at any time. Schneider Electric strongly recommends that you have the most recent and up-to-date version available on www.se.com/ww/en/download.

The technical characteristics of the devices described in this guide also appear online. To access the information online, go to the Schneider Electric home page at www.se.com.

Related Documents

Title of documentation	Reference number
<i>PowerLogic™ HeatTag - Instruction Sheet</i>	MFR51738

You can download these technical publications and other technical information from our website at www.se.com/ww/en/download.

Presentation

PowerLogic Master Range

PowerLogic smooths the power supply, and protects the network, the installation and the operator by improving the power factor and hence the quality of the power. It also allows for remote control of equipment and the monitoring of its performance and condition in real time.

HeatTag Description

Overview

The HeatTag is a wireless sensor for early detection of overheating wire connections or overheating cables.

The HeatTag sensor helps prevent electrical distribution switchboards from being damaged by means of analyzing gas and micro-particles in the air of the switchboard and sending alerts before any smoke or insulator browning.

Features

The HeatTag sensor includes the following features:

- 3 levels of alert according to the criticality of the detected situation
- 11 levels of air quality index (0 to 10)
- Analysis of gas and micro-particles emitted by cable sheaths when overheating
- Measurement of temperature and humidity in the switchboard
- Self-diagnostics
- Communication with Schneider Electric EcoStruxure™ Panel Server or gateways
- Integration in EcoStruxure™ solutions

Air Quality Index

The HeatTag sensor provides an air quality index, ranging from 0 (good) to 10, and displays the air quality evolution trend in a table.

Air quality index from 0 to 9 is provided for information.

An alert is triggered when the air quality index is equal to 10.

Overheating Detection

The HeatTag sensor does not replace the fire protection devices of the building.

⚠ WARNING
HAZARD OF FIRE <ul style="list-style-type: none">• Do not use the HeatTag sensor as a safety device.• Do not disable the other monitoring and safety devices of the equipment. Failure to follow these instructions can result in death, serious injury, or equipment damage.

When the HeatTag sensor has detected an abnormal overheating of the cable sheath in the switchboard (quality index equal to 10), it triggers an alert.

Overheating can be caused by:

- one or several loose connections (too high contact resistance).
- an incorrectly sized cable compared to the rated current.
- overload not detected by the protective equipment.

Alerts are triggered with three criticality levels:

- Low level: a cable is slowly overheating in the installation, you must plan a maintenance visit of the installation.
- Medium level: a cable is overheating in the installation, you must check quickly the installation.
- High level: a cable is overheating in a very short time, you must check the installation immediately.

The operation LED blinks slowly orange when the HeatTag sensor triggers an alert to the Panel Server or gateway.

NOTE: The detection and communication functions of the HeatTag sensor can be disturbed depending on its installation and use in the equipment.

Temperature and Humidity

The HeatTag sensor measures the ambient temperature and humidity. These values are refreshed every 60 s.

The transmission period is 60 s and can be increased by the system in the event of high wireless data traffic.

Self-Diagnostics

The HeatTag sensor carries out two types of diagnostics:

- An alert is triggered when the HeatTag sensor is out of service. In this case it does not report any measurements. The alert remains latched until it is reset.
- An alert is triggered when the fan is clogging (see [Troubleshooting](#), page 23). In this case the HeatTag sensor continues to analyze gas and micro-particles, to trigger air alerts, and to report measurements.

Operation Mode

After switching on the HeatTag power supply:

- The HeatTag sensor is in test mode for 30 minutes. It can be tested with the HeatTag Tester (see [Test With the HeatTag Tester](#), page 18).
- After 30 minutes the HeatTag sensor is in auto-learning mode. It can trigger the first alert. Testing the HeatTag sensor with the HeatTag Tester is not allowed to avoid disturbance during the HeatTag environment-learning period (8 hours).
- After 8 hours the HeatTag sensor has learned its background environment. That is, the HeatTag sensor is in normal operation after a total duration of 8h30.

Each time the HeatTag sensor is powered on, 30 minutes and 8 hours sequences are repeated.

Hardware Description

Description

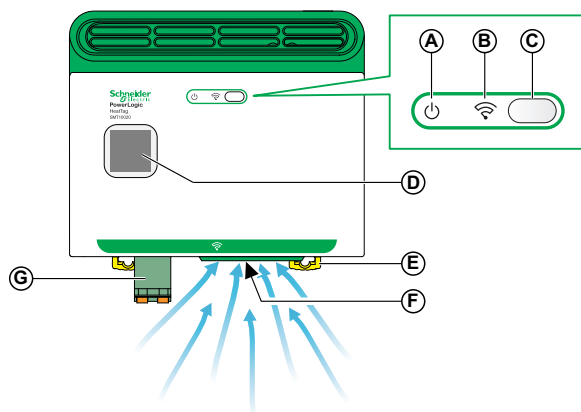

- A. Operation LED
- B. Network status LED
- C. Operation button
- D. QR code to access device information
- E. DIN clip
- F. Air inlet
- G. Power supply connector

For information on installation, consult the instruction sheet available on the Schneider Electric website: [MFR51738](https://www.schneider-electric.com/resources/technical-documents/MFR51738).







Operation LED

The LED indicates the operation mode and alert status of the HeatTag sensor.

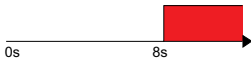
LED indication	Description	Action
	HeatTag sensor switched off.	None
	HeatTag sensor in test mode.	None
	HeatTag sensor in normal operation.	None
	HeatTag sensor has triggered an alert.	Investigate the cause of the heating in the switchboard.
	Minor malfunction detected.	Do maintenance operations on the HeatTag sensor (see Troubleshooting, page 23).
	Major malfunction detected.	Replace the HeatTag sensor.

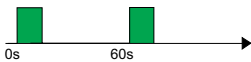
Network Status LED

The LED indicates the communication status with the Panel Server or gateway.

LED indication	Description
	HeatTag sensor is unpaired with factory settings.
	Reset to factory settings in progress.
	HeatTag sensor is searching for a Panel Server or gateway.
	HeatTag sensor in identification mode.
	HeatTag sensor is in the network. Normal communication with the Panel Server or gateway.
	Occasional loss of communication.
	Loss of communication with the Panel Server or gateway.
	Internal error detected.

QR Code

When the QR code on the front face of a HeatTag sensor is scanned with a smartphone running a QR code reader and connected to the Internet, the Go2SE landing page is displayed. The following information is available from the landing page:

- HeatTag commercial reference and serial number
- MAC address of the HeatTag IEEE 802.15.4 network
- IEEE 802.15.4 installation code
- HeatTag technical characteristics
- HeatTag technical publications

Tamper-seal Tapes

Tamper-seal tapes help detect unauthorized access into the device.

The following figures illustrate the position of the two tamper-seal tapes affixed on the HeatTag sensor:

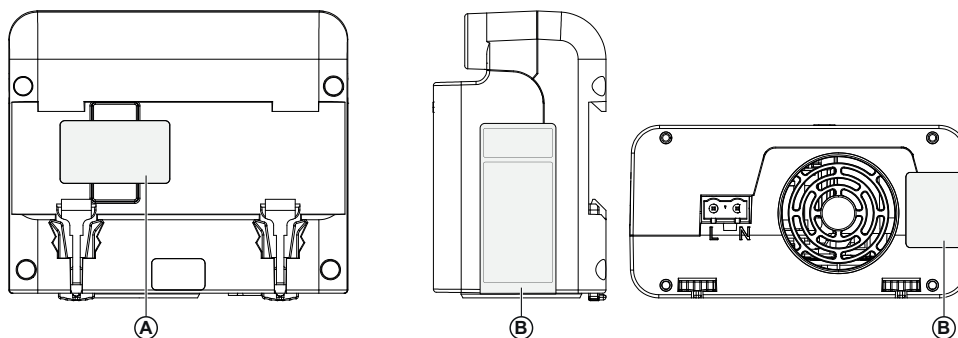

- A. On rear face
- B. Folded on right-hand side and bottom

Technical Characteristics

Electrical Characteristics

Characteristics	Value
Conforming to standards	<ul style="list-style-type: none"> IEC 61010-1:2017 UL/CSA/EU CENELEC deviations IEC 61010-2-201 IEC/EN 61326-1 FCC Part 15B and 15C ETSI/EN 300328 ETSI/EN 301489-1 ETSI/EN 301489-17 IEEE 802.15.4
Supply voltage	110–277 Vac \pm 15%
HeatTag power supply protection	2 A circuit breaker, C curve
Frequency	50–60 Hz
Maximum consumption	0.1 A
Degree of pollution (IEC 60664-1)	3
Overvoltage category	III
Operating frequency	2405–2480 MHz
Maximum radio-frequency power transmitted	<10 mW

Physical Characteristics

Characteristics	Value	
Ambient temperature	During storage	-20 °C to +85 °C (-4 °F to 185 °F)
	In operation	-15 °C to +70 °C (5 °F to 158 °F)
Relative humidity	During storage	5–95%
	In operation	15–90%
Altitude of use	0–2000 m (0–6500 ft)	
Dimensions (W x L x D)	108 x 107 x 55 mm (4.25 x 4.21 x 2.16 in)	
Weight	270 g (2.5 oz)	
Degree of protection (IEC/EN 60529)	IP20	

Sensors Characteristics

Characteristics	Value	
Temperature measurement	Measurement range	-15 °C to +70 °C (5 °F to 158 °F)
	Measurement accuracy	\pm 1.1 °C
	Default transmission period	30 s (higher in case of high wireless data traffic)
Humidity measurement	Measurement range	15–90%
	Measurement accuracy	\pm 9RH%
	Default transmission period	30 s (higher in case of high wireless data traffic)
Air quality	Index (0 to 10). Alert triggered when index equal to 10.	
Test alert after switching on	During the first 30 minutes	

Characteristics	Value
Test alert after pairing	Alert requested by Panel Server or gateway remotely
Auto-learning phase of background environment	8 hours after the first 30 minutes

EU Declaration of Conformity

Hereby, Schneider Electric Industries SAS declares that the HeatTag sensor is in compliance with the essential requirements and other relevant provisions of RED Directive 2014/53/EU. The BE20042401 declaration of conformity can be downloaded on www.se.com/docs.

Schneider Electric Green Premium™ Ecolabel

Description

Green Premium by Schneider Electric is a label that allows you to develop and promote an environmental policy while preserving your business efficiency. This ecolabel is compliant with up-to-date environmental regulations.



Accessing Green Premium

Green Premium data on labeled products can be accessed online through any of the following ways:

- By navigating to the Green Premium page on the Schneider Electric website.
- By flashing the QR code displayed in the following image:



Checking Products Through the Schneider Electric Website

To check the environmental criteria of a product using a PC or smartphone, follow these steps:

1. From www.se.com, select **Support > Green Premium: RoHS, REACH**.
2. Find **Check a Product** and click **Launch now** to open the search tool webpage.
3. Enter the commercial reference or product range of the product to search for.
4. To search for several products simultaneously, click the **Add** button, and then fill in the field.
5. Click **Check product(s)** to generate a report of the environmental criteria available for the products with the entered commercial references.

Environmental Criteria

The Green Premium ecolabel provides documentation on the following criteria about the environmental impact of the products:

- RoHS: European Union Restriction of Hazardous Substances (RoHS) directive.
- REACH: European Union Registration, Evaluation, Authorization, and Restriction of Chemicals regulation.
- PEP: Product Environmental Profile.
- EoLI: End of Life Instructions.

RoHS

Schneider Electric products are subject to RoHS requirements at a worldwide level, even for the many products that are not required to comply with the terms of the regulation. Compliance certificates are available for products that fulfill the criteria of this European initiative, which aims to eliminate hazardous substances.

REACH

Schneider Electric applies the strict REACH regulation on its products at a worldwide level, and discloses extensive information concerning the presence of SVHC (Substances of Very High Concern) in all of these products.

PEP

Schneider Electric publishes complete set of environmental data, including carbon footprint and energy consumption data for each of the life cycle phases on all of its products, in compliance with the ISO 14025 PEP ecopassport program. PEP is especially useful for monitoring, controlling, saving energy, and/or reducing carbon emissions.

EoLI

These instructions provide:

- Recyclability rates for Schneider Electric products.
- Guidance to mitigate personnel hazards during the dismantling of products and before recycling operations.
- Part identification for recycling or for selective treatment, to mitigate environmental hazards/incompatibility with standard recycling processes.

Use

Commissioning

When commissioned, the HeatTag sensor must be paired with Schneider ElectricEcoStruxure Panel Server or gateways. For detailed information about pairing the devices, see the user guide of the relevant Panel Server or gateway:

- DOCA0172EN *EcoStruxure Panel Server - User Guide*
- DOCA0197EN *PrismaSeT Wireless Panel Server - User Guide*
- DOCA0157EN *PowerLogic PowerTag Link Gateway - User Guide*

During the first 30 minutes after switching on the HeatTag sensor, the device is in test mode, that is, the operation LED blinks slowly green and the HeatTag sensor can trigger an overheating alert for test by using the HeatTag Tester or any other alert requested by Panel Server or gateway remotely. It takes another 8 hours for the HeatTag sensor to define its nominal environment and to be fully operational. Each time the HeatTag sensor is powered on, 30 minutes and 8 hours sequences are repeated.

Manual Pairing of the HeatTag Sensor to a Panel Server or Gateway

The HeatTag sensor is not paired and can be manually paired to a Panel Server or gateway when:

- The operation LED is green (blinking or steady).
- The network status LED is steady orange.

To manually pair the HeatTag sensor 3 minutes after switching on:

1. Press the operation button for less than 2 s.

Result: The HeatTag sensor triggers the automatic discovery function of the gateway or Panel Server.

2. The gateway or Panel Server discovers the wireless devices and pairs with the HeatTag sensor.

Result:

- The operation LED is green (blinking or steady).
- The network status LED blinks green.

Unpairing the HeatTag Sensor

The HeatTag sensor has lost communication with the Panel Server or gateway for more than 15 minutes when:

- The operation LED is green (blinking or steady).
- The network status LED flashes red.

To manually unpair the HeatTag sensor:

1. Press the operation button for more than 8 s.
2. When the network status LED turns steady orange, release the button.

If you need to manually pair the HeatTag sensor to a Panel Server or gateway, see the corresponding procedure, page 16.

Acknowledging an Alert

The HeatTag sensor has triggered an alert when :

- The operation LED flashes orange.
- The network status LED blinks green.

If the HeatTag sensor triggered an alert:

1. Investigate the cause of the heating in the switchboard.
2. Acknowledge the alert by pressing the operation button for less than 2 s.

Result: The HeatTag sensor returns to normal operation mode when both the following conditions are met:

- The operation LED turns to steady green.
- The network status LED blinks green.

Resetting the HeatTag Sensor to Factory Settings

The HeatTag sensor has lost communication with the Panel Server or gateway for more than 15 minutes when:

- The operation LED is green (blinking or steady).
- The network status LED flashes red.

To reset the HeatTag sensor to factory settings:

1. Press the operation button for more than 8 s until the network status LED turns steady red.
2. Release the button.

Result: The network status LED turns steady orange (HeatTag sensor unpaired, with factory settings).

If you need to manually pair the HeatTag sensor to a Panel Server or gateway, see the corresponding procedure, page 16.

Test With the HeatTag Tester

Introduction

The HeatTag sensor can be tested with the HeatTag tester during commissioning, within the first 30 minutes after powering on, and whenever needed after the 8-hour environment-learning period.

Only use the tester and HeatTag Tester liquid provided by Schneider Electric to test the HeatTag sensor.

Package Content

The package for testing HeatTag sensors contains the following items:

- One tester with USB charging cable
- One bottle of HeatTag Tester liquid (140 ml (4.7 fl.oz.))

Contact your Schneider Electric local representative to order a new package.

Tester Description

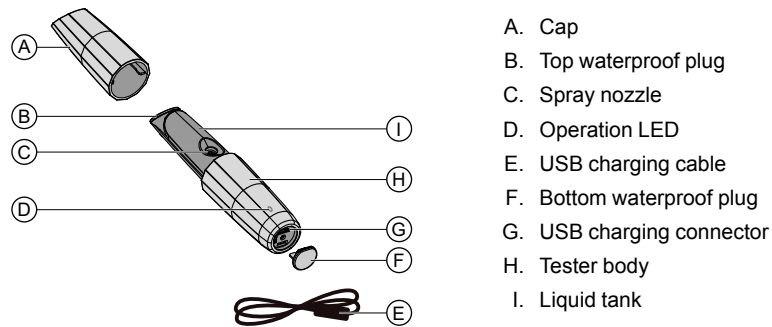

Charging The Tester

Fully charge the HeatTag tester before first use. It takes about 2 hours.

To charge the HeatTag tester, proceed as follows:

1. Pull out the bottom waterproof plug.
2. Connect the USB charging cable to the USB charging connector at the bottom of the tester and to a USB connector. The operation LED flashes red slowly while the tester is charging.
3. Disconnect the tester when it is charged (operation LED on red).
4. Put the bottom waterproof plug on.

Filling the Tester

▲ WARNING

UNINTENDED EQUIPMENT OPERATION

- To test the HeatTag sensor, fill the HeatTag tester only with the HeatTag Tester liquid provided by Schneider Electric.
- Before using the HeatTag Tester liquid, check the validity date printed on the bottle.

Failure to follow these instructions can result in death, serious injury, or equipment damage.

To fill the tester with the HeatTag Tester liquid, proceed as follows:

1. Remove the tester cap by pulling it from the tester body with reasonable force.
2. Pull out the top waterproof plug.
3. Fill the tank with the liquid to the maximum limit indicated.
4. Put the top waterproof plug on.
5. Put the tester cap back into place.

For more information about the HeatTag Tester liquid, see the data sheet, page 25.

Testing the HeatTag Sensor

NOTICE

INOPERATIVE EQUIPMENT

When testing the HeatTag sensor:

- Position the HeatTag tester with the spray nozzle 10 centimeters (3.93 in) away from the air inlet of the HeatTag sensor.
- Spray the liquid for 30 s (minimum) to 45 s (maximum) towards the air inlet of the HeatTag sensor.

Failure to follow these instructions can result in equipment damage.

To test a HeatTag sensor, proceed as follows:

1. Before testing a HeatTag sensor, turn off all power supplying the equipment except the HeatTag sensor and the gateway paired to it.
2. Check that the tester is charged and filled with HeatTag Tester liquid.
3. Position the tester with the spray nozzle 10 centimeters (3.93 in) away from the air inlet of the HeatTag sensor to be tested.
4. Slide the tester cap to the limit. The tester immediately emits fine particles of the liquid.
5. Hold the tester in position and spray the liquid for 30 s (minimum) to 45 s (maximum) towards the air inlet of the HeatTag sensor.

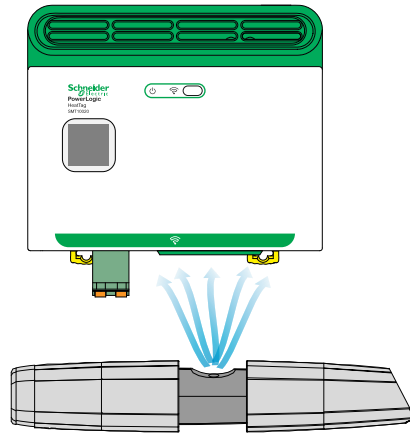

6. Slide the tester cap to close the tester and stop the spray.
7. Check the result of the test:

If...	Then...
The operation LED blinks orange on the HeatTag sensor and an alert is transmitted by the HeatTag sensor to the gateway.	The test is successful. Check the alert on the interface used in the system (for example, EcoStruxure Facility Expert (EFE) app).
The operation LED blinks orange on the HeatTag sensor but no alert is transmitted to the gateway.	The HeatTag sensor has triggered an alert. Check the gateway configuration and pairing, then test the HeatTag sensor with the tester again.
The operation LED on the HeatTag sensor is off.	The HeatTag sensor has not triggered an alert. Contact your Schneider Electric local representative.

8. Empty the tester tank after commissioning a HeatTag sensor or several sensors if all tested at once.

Cleaning the Tester

NOTICE
<p>MESH DIAPHRAGM DAMAGE</p> <p>When the HeatTag tester cap is removed, do not touch the middle area with the mesh diaphragm.</p> <p>Failure to follow these instructions can result in equipment damage.</p>

Clean the tester before adding HeatTag Tester liquid.

To clean the tester, proceed as follows:

1. Remove the tester cap by pulling it from the tester body with reasonable force.
2. Pull out the top waterproof plug.
3. Clean the tank with clear water (50 °C (122 °F) maximum).
4. Put the top waterproof plug on.
5. Put the tester cap back into place.

Technical Characteristics of the Tester

Characteristics	Value
Power supply	3.7 Vdc or 5.0 Vdc with AC adapter
Particle size	Mass Median Aerodynamic Diameter (MMAD) <4 µm (<13.2 µft)
Capacity of tank	5 ml (0.17 fl.oz.)
Dimensions	Ø = 27.5 mm (1.06 in), L = 134 mm (5.28 in)
Weight	62 g (2.2 oz)

Troubleshooting

Problem description	Probable cause	Solutions
Tester operation LED is on blue but no spray when operating the tester.	Battery low.	Charge the tester.
	Spray nozzle pounding.	Use a clean tissue to absorb the liquid. Do not touch the middle area with the mesh diaphragm.
	Incorrect liquid.	Pour out of all the remaining liquid, clean the tank with clear water, and fill with the correct liquid.
Tester operation LED is off and no spray when operating the tester.	Tester inoperative.	Contact your Schneider Electric local representative.
The tester cannot be charged.	USB charging cable damaged.	Use another USB cable.
	USB power supply damaged.	Use another USB power supply.
	Tester not used for a long time, low battery.	Charge the tester during more than 2.5 hours. If the tester still does not work, contact your Schneider Electric local representative.
	Charging port ageing or tester damaged.	Contact your Schneider Electric local representative.

Remote Use of Data

Paired with Schneider Electric EcoStruxure Panel Server or gateways, the HeatTag sensor reports:

- Alerts after overheating detection (3 levels)
- Air quality index
- Temperature and humidity measurement
- Self-diagnostics alerts

The following tools are available to remotely access data of the HeatTag sensor:

- EcoStruxure Facility Expert (EFE) app and software
- EcoStruxure Power Monitoring Expert (PME) software
- Remote controllers

EcoStruxure Facility Expert App and Software

The EcoStruxure Facility Expert mobile application can be downloaded on Android and iOS smartphones. For smartphone compatibility, check on your application store.

EcoStruxure Facility Expert optimizes operations and maintenance, helping to ensure business continuity, and provides insights to service providers or facility managers.

EcoStruxure Facility Expert is a real-time collaborative technology available on mobile devices and PCs that enables managers and maintenance personnel to be connected with facilities and equipment. Information exchange between users is simple and fast.

From Remote Controller

Refer to the Modbus table in the appropriate gateway or Panel Server user guide (referenced in *Commissioning*, page 16) to see which data is available through the gateway.

Troubleshooting

Problem description	Probable cause	Solutions
The operation LED blinks fast red after a HeatTag self-diagnostics.	Fan clogging detected in the HeatTag sensor.	Clean the fan air inlet (see detailed procedure, page 23).
The operation LED turns on red after a HeatTag self-diagnostics.	HeatTag sensor inoperative.	Replace the HeatTag sensor.

Cleaning the HeatTag Fan Air Inlet

⚠️ DANGER

HAZARD OF ELECTRIC SHOCK, EXPLOSION, OR ARC FLASH

Before maintaining the HeatTag sensor:

- Check that the HeatTag sensor is de-energized.
- Always use a properly rated voltage sensing device to confirm that the HeatTag sensor is de-energized.

Failure to follow these instructions will result in death or serious injury.

NOTICE

INOPERATIVE EQUIPMENT

- Do not use chemical cleaning products or products containing solvents.
- Use only a dry air duster.
- Follow the instructions to position and use the dry air duster.

Failure to follow these instructions can result in equipment damage.

Proceed as follows to clean the HeatTag fan air inlet with dry air duster:

1. Check that the *tamper-seal tapes* are not damaged. If the tamper-seal tapes are damaged or missing, contact your Schneider Electric local representative.
2. Disassemble the HeatTag sensor from the DIN rail.
3. Put the HeatTag rear face on a flat surface, the HeatTag fan air inlet towards you.
4. Position the dry air duster vertically (spray nozzle to the top), 5 centimeters (1.97 in) away from the fan air inlet and spray dry air for 10 s on the fan air inlet.
5. Re-install the HeatTag sensor.
6. Switch on the HeatTag sensor.
7. Check that the HeatTag sensor is in normal operation (operation LED steady green).
8. If the problem persists, do the cleaning procedure again.
9. If the problem persists, replace the HeatTag sensor.

Appendices

HeatTag Tester Liquid - Safety Data Sheet

SAFETY DATA SHEET (REGULATION (EC) n° 1907/2006 - REACH) Version 1.3 (31/08/2020) - Page 1/6
 Bio Concept - Conceptarome **SOLUTION SCHNEIDER - SCHNEIDER**

SAFETY DATA SHEET

(REACH regulation (EC) n° 1907/2006 - n° 2015/830)

SECTION 1 : IDENTIFICATION OF THE SUBSTANCE/MIXTURE AND OF THE COMPANY/UNDERTAKING

1.1. Product identifier

Product name : SOLUTION SCHNEIDER
 Product code : SCHNEIDER.

1.2. Relevant identified uses of the substance or mixture and uses advised against

1.3. Details of the supplier of the safety data sheet

Registered company name : Bio Concept - Conceptarome.
 Address : 1 bis rue des herbillaux.79000.NIORT.FRANCE.
 Telephone : +33 (0)549262500. Fax : .
 commercialbioconcept@gmail.com

1.4. Emergency telephone number : +33 (0)1 45 42 59 59.

Association/Organisation : INRS / ORFILA <http://www.centres-antipoison.net>.

SECTION 2 : HAZARDS IDENTIFICATION

2.1. Classification of the substance or mixture

In compliance with EC regulation No. 1272/2008 and its amendments.

This mixture does not present a physical hazard. Refer to the recommendations regarding the other products present on the site.
 This mixture does not present a health hazard with the exception of possible occupational exposure thresholds (see paragraphs 3 and 8).
 This mixture does not present an environmental hazard. No known or foreseeable environmental damage under standard conditions of use.

2.2. Label elements

In compliance with EC regulation No. 1272/2008 and its amendments.

No labelling requirements for this mixture.

2.3. Other hazards

The mixture does not contain substances classified as 'Substances of Very High Concern' (SVHC) $\geq 0.1\%$ published by the European Chemicals Agency (ECHA) under article 57 of REACH: <http://echa.europa.eu/fr/candidate-list-table>
 The mixture fulfils neither the PBT nor the vPvB criteria for mixtures in accordance with annexe XIII of the REACH regulations EC 1907/2006.

SECTION 3 : COMPOSITION/INFORMATION ON INGREDIENTS

3.2. Mixtures

Composition :

Identification	(EC) 1272/2008	Note	%
CAS: 56-81-5 EC: 200-289-5 GLYCEROL		[1]	2.5 \leq x % < 10
CAS: 57-55-6 EC: 200-338-0 REACH: 01-21194568009-23 PROPYLENE GLYCOL		[1]	2.5 \leq x % < 10

Information on ingredients :

[1] Substance for which maximum workplace exposure limits are available.

SECTION 4 : FIRST AID MEASURES

As a general rule, in case of doubt or if symptoms persist, always call a doctor.
 NEVER induce swallowing by an unconscious person.

4.1. Description of first aid measures

In the event of splashes or contact with eyes :

Wash thoroughly with fresh, clean water for 15 minutes holding the eyelids open.

- Made under licence of European Label System® MSDS software from InfoDyne - <http://www.infodyne.fr> -

SAFETY DATA SHEET (REGULATION (EC) n° 1907/2006 - REACH)
Bio Concept - Conceptarome

Version 1.3 (31/08/2020) - Page 2/6

SOLUTION SCHNEIDER - SCHNEIDER**In the event of swallowing :**

In the event of swallowing, if the quantity is small (no more than one mouthful), rinse the mouth with water and consult a doctor.

Keep the person exposed at rest. Do not force vomiting.

Seek medical attention, showing the label.

If swallowed accidentally, call a doctor to ascertain whether observation and hospital care will be necessary. Show the label.

4.2. Most important symptoms and effects, both acute and delayed

No data available.

4.3. Indication of any immediate medical attention and special treatment needed

No data available.

SECTION 5 : FIREFIGHTING MEASURES

Non-flammable.

5.1. Extinguishing media**Suitable methods of extinction**

In the event of a fire, use :

- sprayed water or water mist

- foam

- multipurpose ABC powder

- BC powder

- carbon dioxide (CO₂)

Unsuitable methods of extinction

In the event of a fire, do not use :

- water jet

5.2. Special hazards arising from the substance or mixture

A fire will often produce a thick black smoke. Exposure to decomposition products may be hazardous to health.

Do not breathe in smoke.

In the event of a fire, the following may be formed :

- carbon monoxide (CO)

- carbon dioxide (CO₂)

5.3. Advice for firefighters

No data available.

SECTION 6 : ACCIDENTAL RELEASE MEASURES**6.1. Personal precautions, protective equipment and emergency procedures**

Consult the safety measures listed under headings 7 and 8.

For first aid worker

First aid workers will be equipped with suitable personal protective equipment (See section 8).

6.2. Environmental precautions

Contain and control the leaks or spills with non-combustible absorbent materials such as sand, earth, vermiculite, diatomaceous earth in drums for waste disposal.

Prevent any material from entering drains or waterways.

6.3. Methods and material for containment and cleaning up

Clean preferably with a detergent, do not use solvents.

6.4. Reference to other sections

No data available.

SECTION 7 : HANDLING AND STORAGE

Requirements relating to storage premises apply to all facilities where the mixture is handled.

7.1. Precautions for safe handling

Always wash hands after handling.

Ensure that there is adequate ventilation, especially in confined areas.

Fire prevention :

Handle in well-ventilated areas.

Prevent access by unauthorised personnel.

SOLUTION SCHNEIDER - SCHNEIDER

Recommended equipment and procedures :

For personal protection, see section 8.
Observe precautions stated on label and also industrial safety regulations.
Packages which have been opened must be reclosed carefully and stored in an upright position.

Prohibited equipment and procedures :

No smoking, eating or drinking in areas where the mixture is used.

7.2. Conditions for safe storage, including any incompatibilities

No data available.

Storage

Keep the container tightly closed in a dry, well-ventilated place.
The floor must be impermeable and form a collecting basin so that, in the event of an accidental spillage, the liquid cannot spread beyond this area.

Packaging

Always keep in packaging made of an identical material to the original.

7.3. Specific end use(s)

No data available.

SECTION 8 : EXPOSURE CONTROLS/PERSONAL PROTECTION

8.1. Control parameters

Occupational exposure limits :

- Belgium (Arrêté du 09/03/2014, 2014) :

CAS	TWA :	STEL :	Ceiling :	Definition :	Criteria :
56-81-5	10 mg/m ³				

- France (INRS - ED984 / 2019-1487) :

CAS	VME-ppm :	VME-mg/m ³ :	VLE-ppm :	VLE-mg/m ³ :	Notes :	TMP No :
56-81-5	-	10	-	-	-	-

- UK / WEL (Workplace exposure limits, EH40/2005, 2011) :

CAS	TWA :	STEL :	Ceiling :	Definition :	Criteria :
56-81-5	- ppm 10 mg/m ³	- ppm - mg/m ³			
57-55-6	150 ppm 474 mg/m ³	- ppm - mg/m ³			

8.2. Exposure controls

Personal protection measures, such as personal protective equipment

Pictogram(s) indicating the obligation of wearing personal protective equipment (PPE) :



Use personal protective equipment that is clean and has been properly maintained.
Store personal protective equipment in a clean place, away from the work area.
Never eat, drink or smoke during use. Remove and wash contaminated clothing before re-using. Ensure that there is adequate ventilation, especially in confined areas.

- Eye / face protection

Avoid contact with eyes.
Use eye protectors designed to protect against liquid splashes
Before handling, wear safety goggles in accordance with standard EN166.

- Hand protection

Wear suitable protective gloves in the event of prolonged or repeated skin contact.
Type of gloves recommended :
- Nitrile rubber (butadiene-acrylonitrile copolymer rubber (NBR))

- Body protection

Work clothing worn by personnel shall be laundered regularly.
After contact with the product, all parts of the body that have been soiled must be washed.

SAFETY DATA SHEET (REGULATION (EC) n° 1907/2006 - REACH)
Bio Concept - Conceptarome

Version 1.3 (31/08/2020) - Page 4/6

SOLUTION SCHNEIDER - SCHNEIDER**SECTION 9 : PHYSICAL AND CHEMICAL PROPERTIES****9.1. Information on basic physical and chemical properties****General information :**

Physical state : Fluid liquid.

Important health, safety and environmental information

pH : Not stated.

Neutral.

Boiling point/boiling range : Not relevant.

Flash point interval : Not relevant.

Vapour pressure (50°C) : Below 110 kPa (1.10 bar).

Density : > 1

Water solubility : Dilutable.

Viscosity: $v < 7 \text{ mm}^2/\text{s}$ (40°C)

Melting point/melting range : Not relevant.

Self-ignition temperature : Not relevant.

Decomposition point/decomposition range : Not relevant.

9.2. Other information

No data available.

SECTION 10 : STABILITY AND REACTIVITY**10.1. Reactivity**

No data available.

10.2. Chemical stability

This mixture is stable under the recommended handling and storage conditions in section 7.

10.3. Possibility of hazardous reactions

When exposed to high temperatures, the mixture can release hazardous decomposition products, such as carbon monoxide and dioxide, fumes and nitrogen oxide.

10.4. Conditions to avoid

No data available.

10.5. Incompatible materials

No data available.

10.6. Hazardous decomposition products

The thermal decomposition may release/form :

- carbon monoxide (CO)

- carbon dioxide (CO₂)**SECTION 11 : TOXICOLOGICAL INFORMATION****11.1. Information on toxicological effects**

Splashes in the eyes may cause irritation and reversible damage

11.1.1. Substances

No toxicological data available for the substances.

11.1.2. Mixture

No toxicological data available for the mixture.

SECTION 12 : ECOLOGICAL INFORMATION**12.1. Toxicity****12.1.2. Mixtures**

No aquatic toxicity data available for the mixture.

12.2. Persistence and degradability

No data available.

12.3. Bioaccumulative potential

No data available.

12.4. Mobility in soil

SAFETY DATA SHEET (REGULATION (EC) n° 1907/2006 - REACH)
Bio Concept - Conceptarome

Version 1.3 (31/08/2020) - Page 5/6

SOLUTION SCHNEIDER - SCHNEIDER

No data available.

12.5. Results of PBT and vPvB assessment

No data available.

12.6. Other adverse effects

No data available.

SECTION 13 : DISPOSAL CONSIDERATIONS

Proper waste management of the mixture and/or its container must be determined in accordance with Directive 2008/98/EC.

13.1. Waste treatment methods

Do not pour into drains or waterways.

Waste :

Waste management is carried out without endangering human health, without harming the environment and, in particular without risk to water, air, soil, plants or animals.

Recycle or dispose of waste in compliance with current legislation, preferably via a certified collector or company.

Do not contaminate the ground or water with waste, do not dispose of waste into the environment.

Soiled packaging :

Empty container completely. Keep label(s) on container.

Give to a certified disposal contractor.

SECTION 14 : TRANSPORT INFORMATION

Exempt from transport classification and labelling.

14.1. UN number

-

14.2. UN proper shipping name

-

14.3. Transport hazard class(es)

-

14.4. Packing group

-

14.5. Environmental hazards

-

14.6. Special precautions for user

-

SECTION 15 : REGULATORY INFORMATION

15.1. Safety, health and environmental regulations/legislation specific for the substance or mixture

- Classification and labelling information included in section 2:

The following regulations have been used:

- EU Regulation No. 1272/2008 amended by EU Regulation No. 2020/217 (ATP 14)

- Container information:

No data available.

- Particular provisions :

No data available.

15.2. Chemical safety assessment

No data available.

SECTION 16 : OTHER INFORMATION

Since the user's working conditions are not known by us, the information supplied on this safety data sheet is based on our current level of knowledge and on national and community regulations.

The mixture must not be used for other uses than those specified in section 1 without having first obtained written handling instructions.

It is at all times the responsibility of the user to take all necessary measures to comply with legal requirements and local regulations.

The information in this safety data sheet must be regarded as a description of the safety requirements relating to the mixture and not as a guarantee of the properties thereof.

SAFETY DATA SHEET (REGULATION (EC) n° 1907/2006 - REACH)
Bio Concept - Conceptarome

Version 1.3 (31/08/2020) - Page 6/6

SOLUTION SCHNEIDER - SCHNEIDER

Abbreviations :

ADR : European agreement concerning the international carriage of dangerous goods by Road.

IMDG : International Maritime Dangerous Goods.

IATA : International Air Transport Association.

ICAO : International Civil Aviation Organisation

RID : Regulations concerning the International carriage of Dangerous goods by rail.

WGK : Wassergefährdungsklasse (Water Hazard Class).

PBT: Persistent, bioaccumulable and toxic.

vPvB : Very persistent, very bioaccumulable.

SVHC : Substances of very high concern.

Schneider Electric
35 rue Joseph Monier
92500 Rueil Malmaison
France

+ 33 (0) 1 41 29 70 00

www.se.com

As standards, specifications, and design change from time to time,
please ask for confirmation of the information given in this publication.

© 2021 – Schneider Electric. All rights reserved.

DOCA0171EN-00