

NH fuse-links gG 500 - 690VAC

with striker size 0, 1, 2, 3, 4

LOW VOLTAGE IEC FUSES

IEC NH FUSE-LINKS



The NH system is classified among plug-in fuse systems and is composed of:

- fuse-base (possibly including terminal covers and phase barriers)
- fuse-link with blade contact
- fuse-link replacement device (LV HRC fuse puller)

Since the design of this system cannot guarantee non-interchangeability of rated current it must be handled by a qualified professional.

Type “gG” NH fuse-links are full range breaking capacity fuse-links and are used to protect cables and equipment. They can interrupt any current surge, from the lowest fusing current up to their breaking capacity, and so can be used alone as protection. They also protect electrical devices and industrial set-ups from the electrodynamic effects of very high short-circuit currents.

TECHNICAL DATA OVERVIEW

Voltage Range AC	500 ... 690 VAC
Ampere Range (A)	32 ... 1250 A
Size per Standard	Sizes 0 to 4 - with striker
Speed/Characteristic	gG
I.R. AC	80 ... 120 kA
Body Material	ceramic
Contact Materials	copper, silver-plated

FEATURES & BENEFITS

- Dimensions according to DIN 43 620 Parts 1 to 4
- Lead free contact blades
- 0% cadmium

APPLICATIONS

- gG: General purpose cable and line protection

STANDARDS

- VDE 0636 Part 201
- IEC 60269-1 and -2



NH fuse-links gG 500 - 690VAC

with striker size 0, 1, 2, 3, 4

PRODUCT RANGE



NH0GG50V160P-2

Size 0 gG with striker

Catalog number	Item number	Rated voltage AC (IEC)	Rated current I _n	Rated breaking capacity AC	Power dissipation at I _n	Weight
NH0GG69V32P-2	P213637	690 V	32 A	80 kA	3.7 W	0.275 kg
NH0GG69V35P-2	S214146	690 V	35 A	80 kA	4 W	0.2936 kg
NH0GG69V40P-2	W214655	690 V	40 A	80 kA	4.5 W	0.275 kg
NH0GG69V50P-2	B215166	690 V	50 A	80 kA	5.2 W	0.275 kg
NH0GG69V63P-2	D215674	690 V	63 A	80 kA	6.2 W	0.311 kg
NH0GG69V80P-2	J216185	690 V	80 A	80 kA	7.5 W	0.29 kg
NH0GG69V100P-2	H216690	690 V	100 A	80 kA	8.5 W	0.275 kg
NH0GG50V125P-2	V217207	500 V	125 A	120 kA	10.7 W	0.2926 kg
NH0GG50V160P-2	A217718	500 V	160 A	120 kA	13.5 W	0.275 kg
NH0GG50V200P-2	K218233	500 V	200 A	120 kA	15 W	0.275 kg



NH1GG50V355P-2

Size 1 gG with striker

Catalog number	Item number	Rated voltage AC (IEC)	Rated current I _n	Rated breaking capacity AC	Power dissipation at I _n	Weight
NH1GG69V80P-2	Y218751	690 V	80 A	80 kA	6.9 W	0.3816 kg
NH1GG69V100P-2	M219270	690 V	100 A	80 kA	8.1 W	0.3833 kg
NH1GG69V125P-2	P219801	690 V	125 A	80 kA	9.6 W	0.347 kg
NH1GG69V160P-2	Z222478	690 V	160 A	80 kA	11.9 W	0.3833 kg
NH1GG69V200P-2	R223000	690 V	200 A	80 kA	14.9 W	0.347 kg
NH1GG50V224P-2	Y200788	500 V	224 A	120 kA	16.7 W	0.347 kg
NH1GG50V250P-2	Q201333	500 V	250 A	120 kA	18.7 W	0.3783 kg
NH1GG50V315P-2	Z201847	500 V	315 A	120 kA	25 W	0.347 kg
NH1GG50V355P-2	W211067	500 V	355 A	120 kA	28 W	0.347 kg

Size 2 gG with striker

Catalog number	Item number	Rated voltage AC (IEC)	Rated current I _n	Rated breaking capacity AC	Power dissipation at I _n	Weight
NH2GG69V125P-2	W212102	690 V	125 A	80 kA	9.5 W	0.564 kg
NH2GG69V160P-2	L212622	690 V	160 A	80 kA	11.5 W	0.564 kg
NH2GG69V200P-2	Y213139	690 V	200 A	80 kA	14.5 W	0.564 kg
NH2GG69V224P-2	Q213638	690 V	224 A	80 kA	16 W	0.569 kg
NH2GG69V250P-2	T214147	690 V	250 A	80 kA	17.5 W	0.564 kg
NH2GG69V315P-2	X214656	690 V	315 A	80 kA	23 W	0.564 kg
NH2GG50V355P-2	E215675	500 V	355 A	120 kA	25 W	0.564 kg
NH2GG50V400P-2	K216186	500 V	400 A	120 kA	29 W	0.564 kg
NH2GG50V500P-2	W217208	500 V	500 A	120 kA	39 W	0.6033 kg



NH3GG50V630P-2

Size 3 gG with striker

Catalog number	Item number	Rated voltage AC (IEC)	Rated current I _n	Rated breaking capacity AC	Power dissipation at I _n	Weight
NH3GG69V315P-2	B217719	690 V	315 A	80 kA	23 W	0.871 kg
NH3GG69V355P-2	L218234	690 V	355 A	80 kA	25 W	0.871 kg
NH3GG69V400P-2	Z218752	690 V	400 A	80 kA	29 W	0.871 kg
NH3GG69V500P-2	N219271	690 V	500 A	80 kA	39 W	0.871 kg
NH3GG50V630P-2	Q219802	500 V	630 A	120 kA	47 W	0.871 kg

MERSEN reserves the right to change, update or correct, without notice, any information contained in this datasheet.

NH fuse-links gG 500 - 690VAC

with striker size 0, 1, 2, 3, 4

PRODUCT RANGE

Size 4 gG with striker

Catalog number	Item number	Rated voltage AC (IEC)	Rated current I _n	Rated breaking capacity AC	Power dissipation at I _n	Weight
NH4GG69V500P-2	S1000079	690 V	500 A	120 kA	40 W	2.2 kg
NH4GG69V630P-2	T1000080	690 V	630 A	120 kA	53 W	2.2 kg
NH4GG69V800P-2	V1000081	690 V	800 A	120 kA	68 W	2.2 kg
NH4GG50V1000P-2	W1000082	500 V	1000 A	120 kA	65 W	2.2 kg
NH4GG50V1250P-2	X1000083	500 V	1250 A	120 kA	61 W	2.2 kg

TECHNICAL DATA

	Size 0	Size 1	Size 2	Size 3	Size 4 gG with striker
Rated current	32 ... 200 A	80 ... 355 A	125 ... 500 A	315 ... 630 A	500 ... 1250 A
Rated voltage AC	500 ... 690 V	500 ... 690 V	500 ... 690 V	500 ... 690 V	500 ... 690 V
Indication System	with striker	with striker	with striker	with striker	with striker

MERSEN reserves the right to change, update or correct, without notice, any information contained in this datasheet.

NH fuse-links gG 500 - 690VAC

with striker size 0, 1, 2, 3, 4

TIME CURRENT CHARACTERISTIC CURVES

Size 0-1-2-3, 690V gG

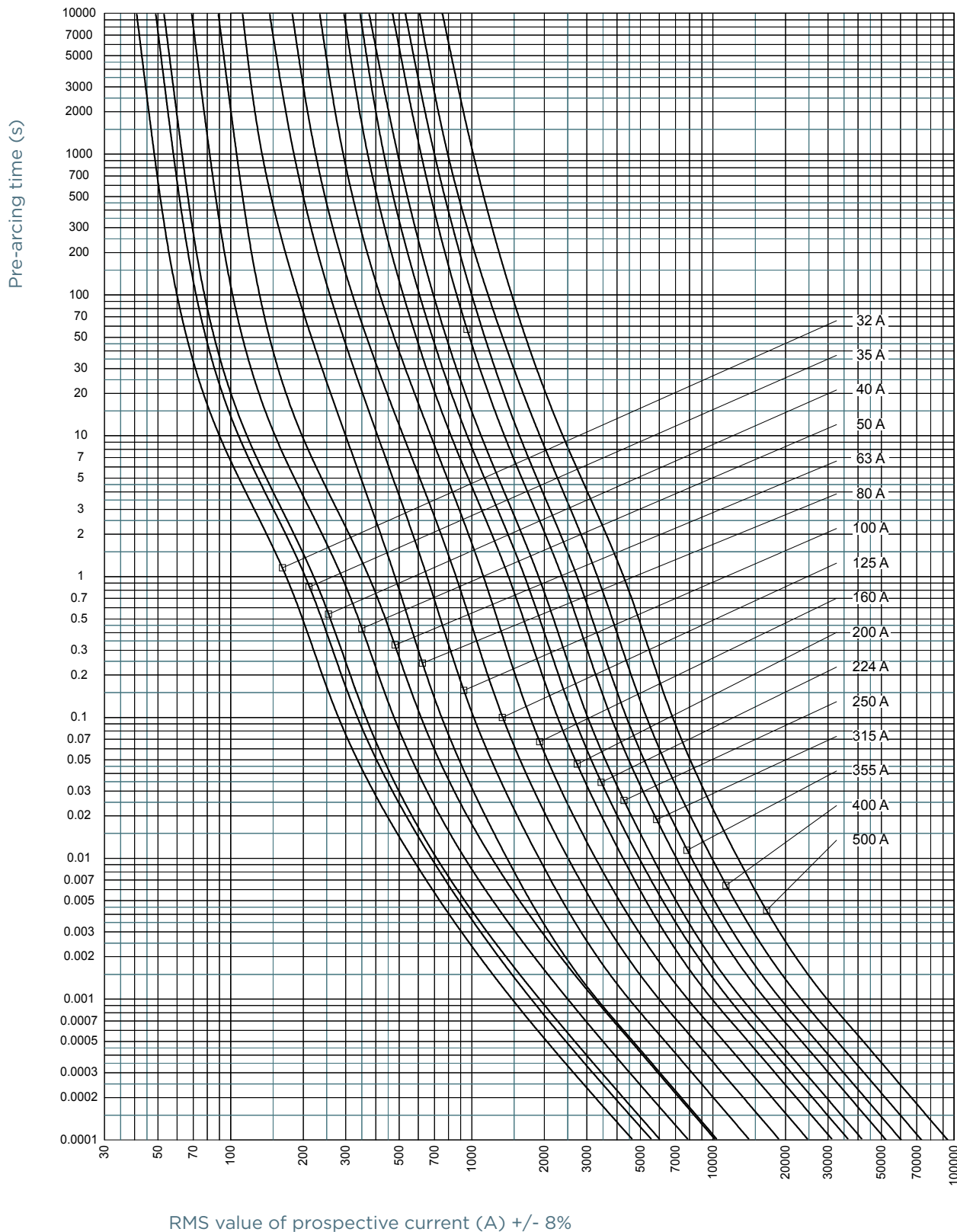

MERSEN reserves the right to change, update or correct, without notice, any information contained in this datasheet.

NH fuse-links gG 500 - 690VAC

with striker size 0, 1, 2, 3, 4

TIME CURRENT CHARACTERISTIC CURVES

Size 4, 690V gG

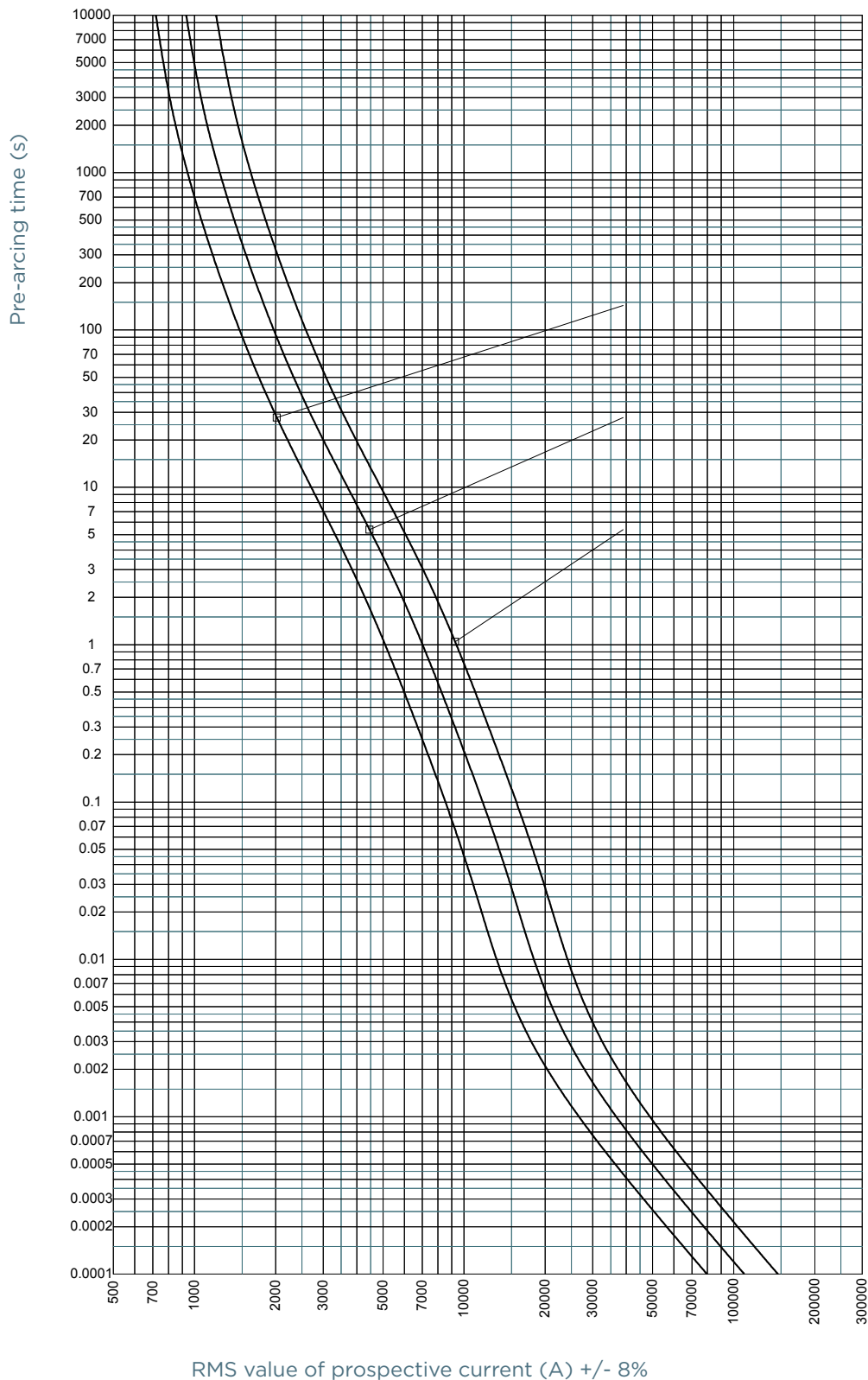

MERSEN reserves the right to change, update or correct, without notice, any information contained in this datasheet.

NH fuse-links gG 500 - 690VAC

with striker size 0, 1, 2, 3, 4

TIME CURRENT CHARACTERISTIC CURVES

Size 0-1-2-3, 500V gG

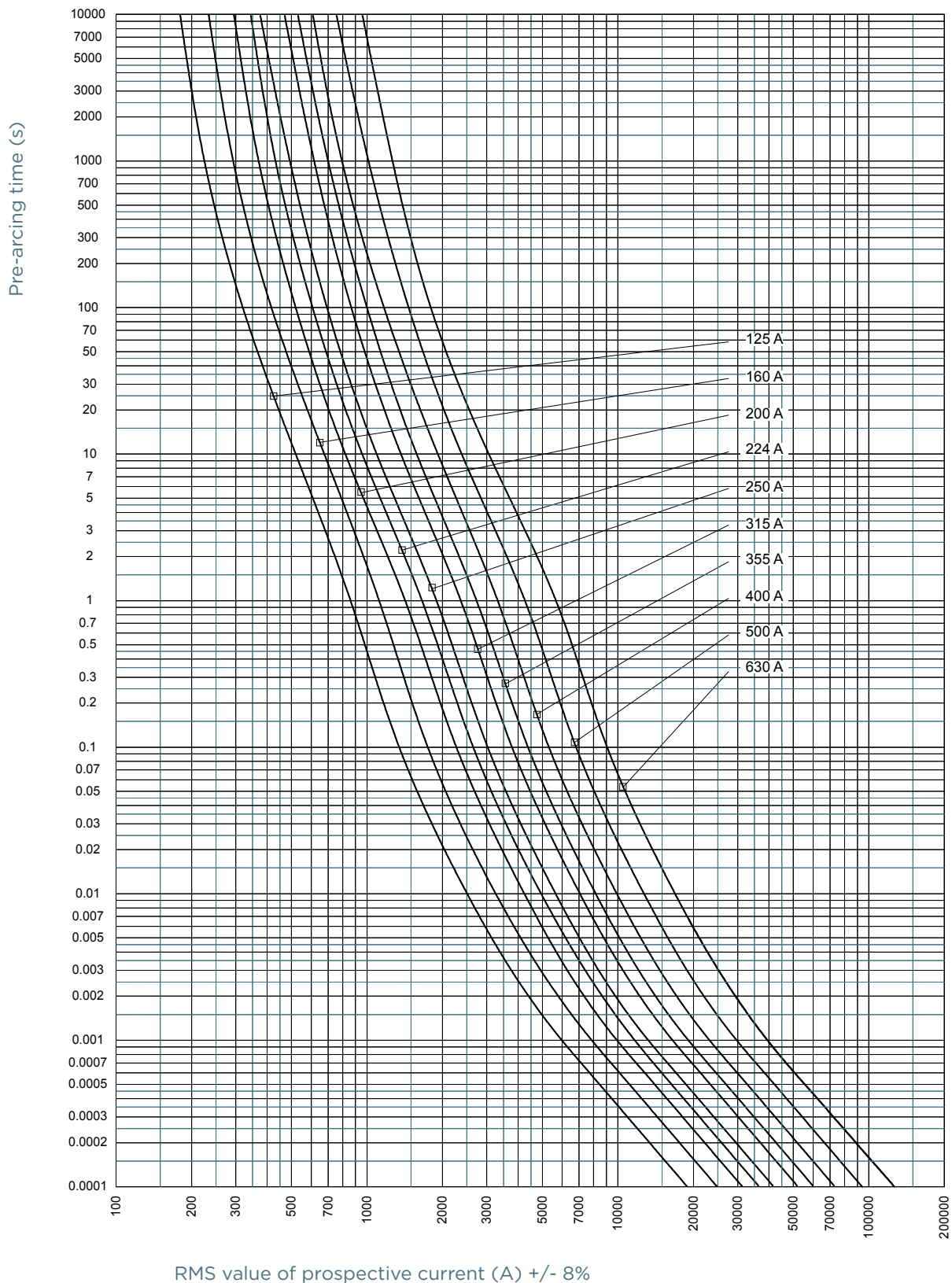

MERSEN reserves the right to change, update or correct, without notice, any information contained in this datasheet.

NH fuse-links gG 500 - 690VAC

with striker size 0, 1, 2, 3, 4

TIME CURRENT CHARACTERISTIC CURVES

Size 4, 500V gG

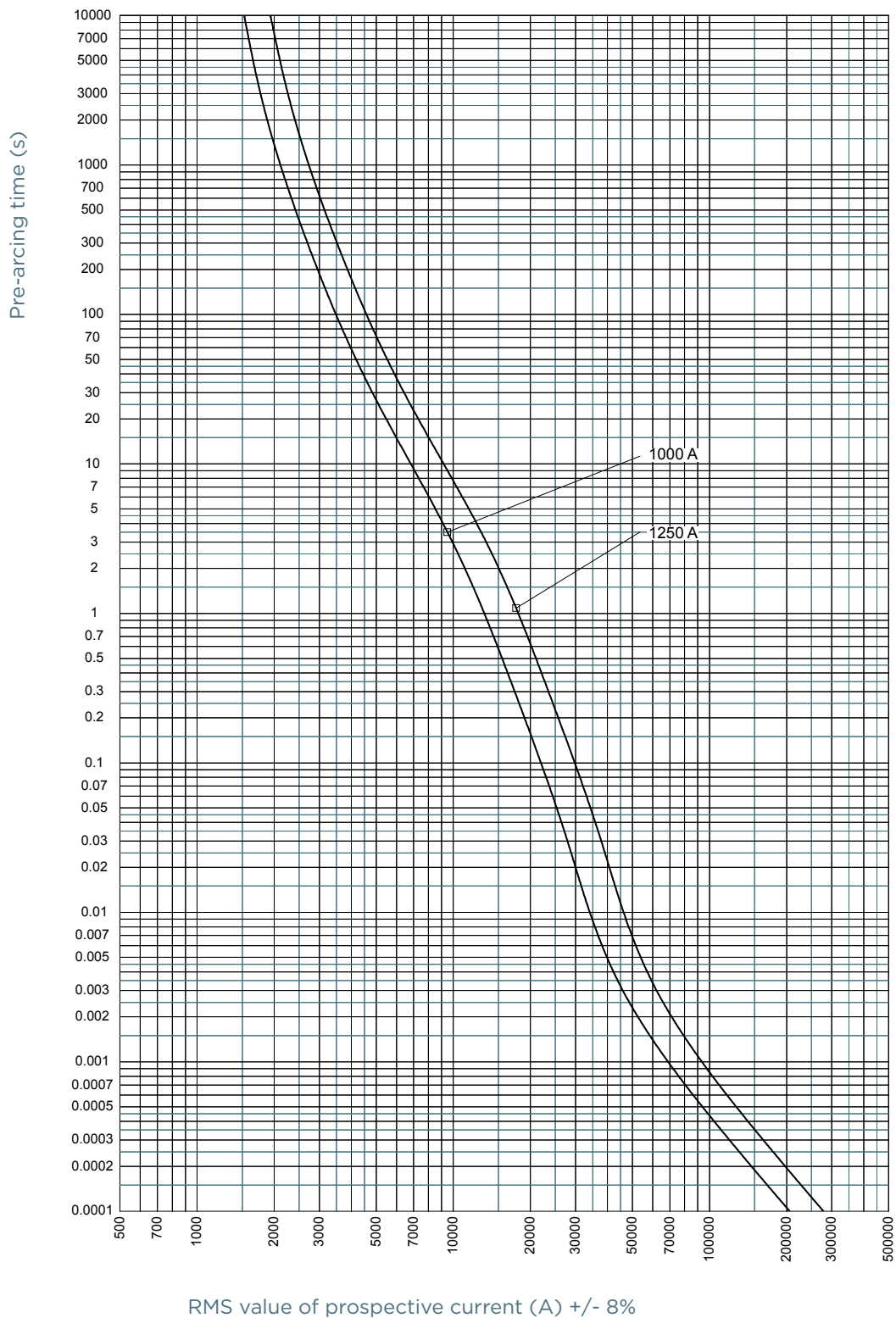

MERSEN reserves the right to change, update or correct, without notice, any information contained in this datasheet.

NH fuse-links gG 500 - 690VAC

with striker size 0, 1, 2, 3, 4

CUT-OFF CURRENT CHARACTERISTIC

Size 0-1, 690V gG

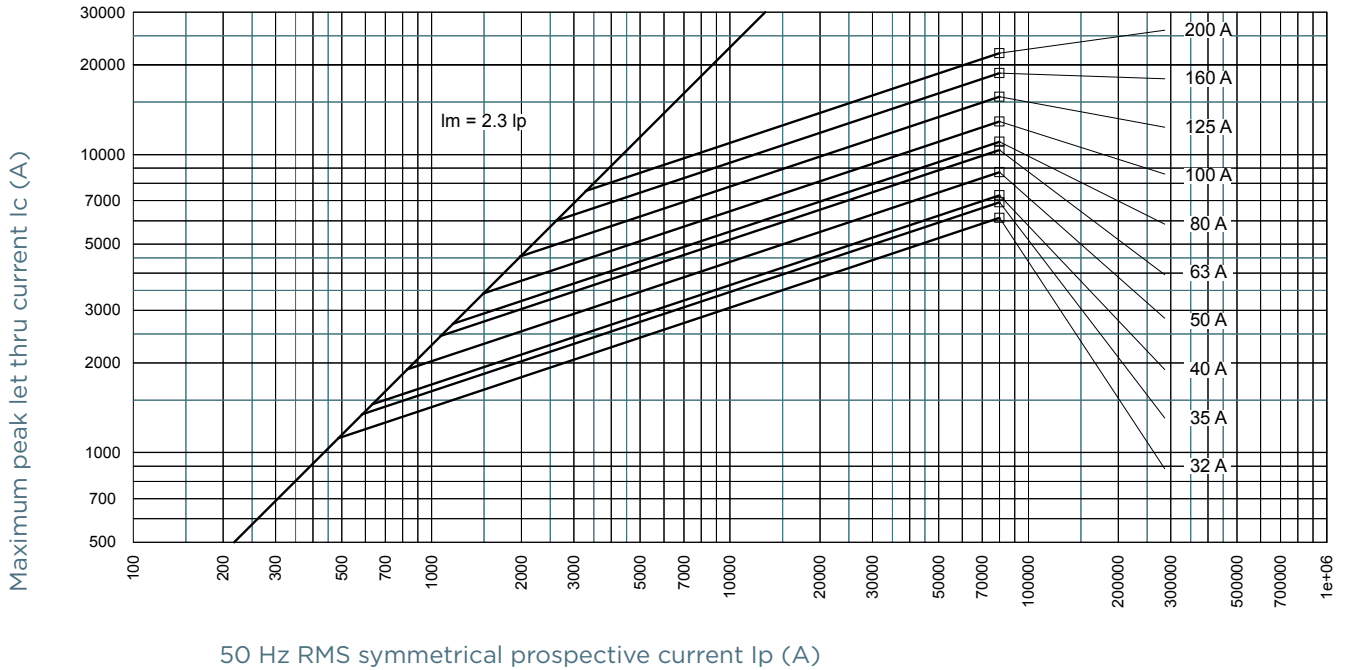

Size 2-3, 690V gG

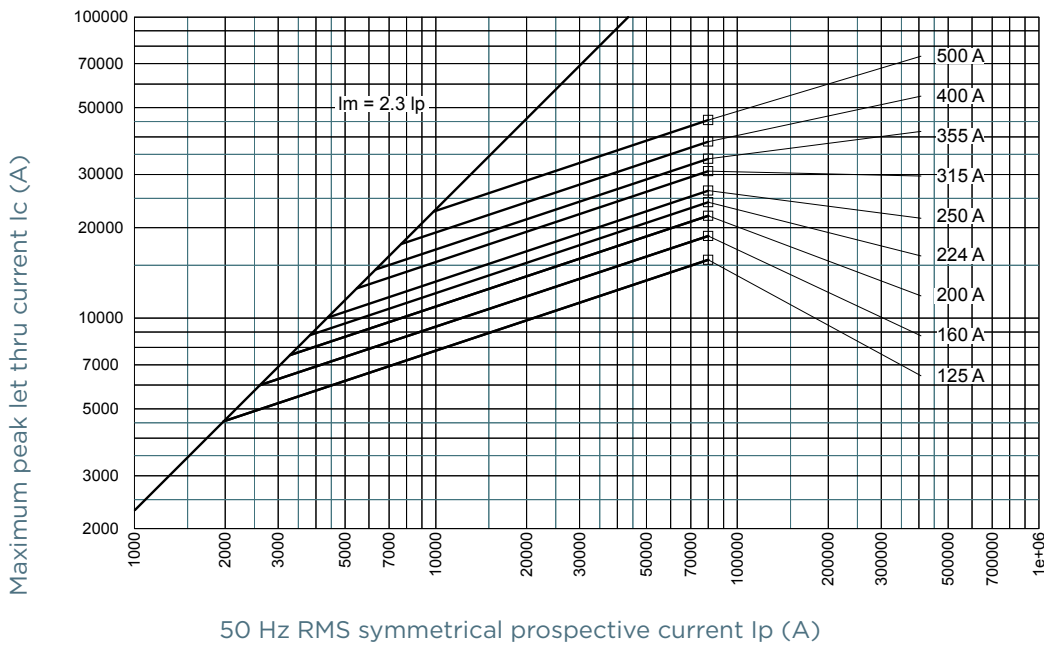

MERSEN reserves the right to change, update or correct, without notice, any information contained in this datasheet.

NH fuse-links gG 500 - 690VAC

with striker size 0, 1, 2, 3, 4

CUT-OFF CURRENT CHARACTERISTIC

Size 4, 690V gG

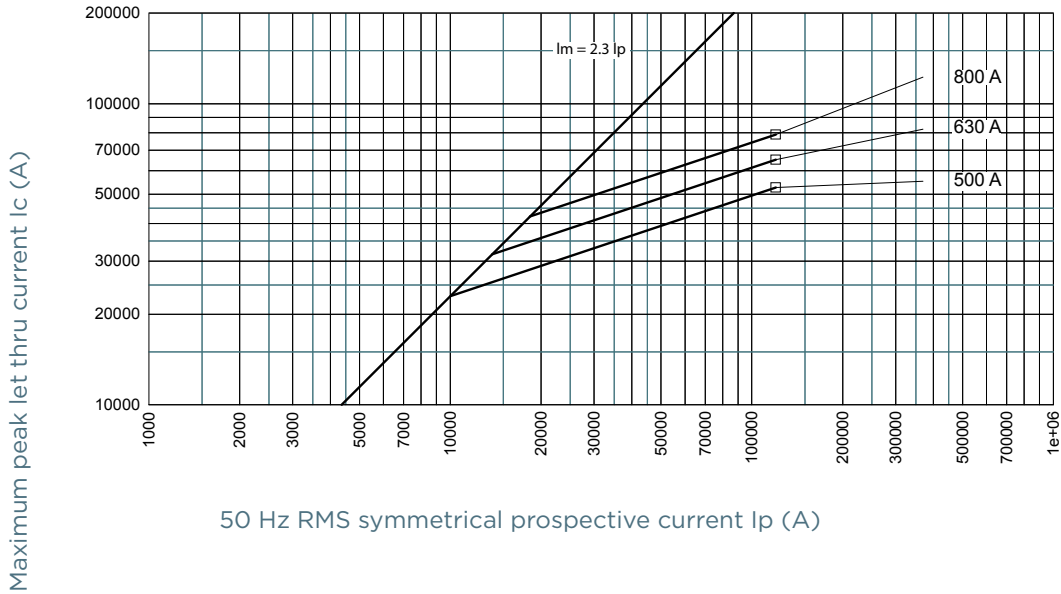

Size 0-1-2-3, 500V gG

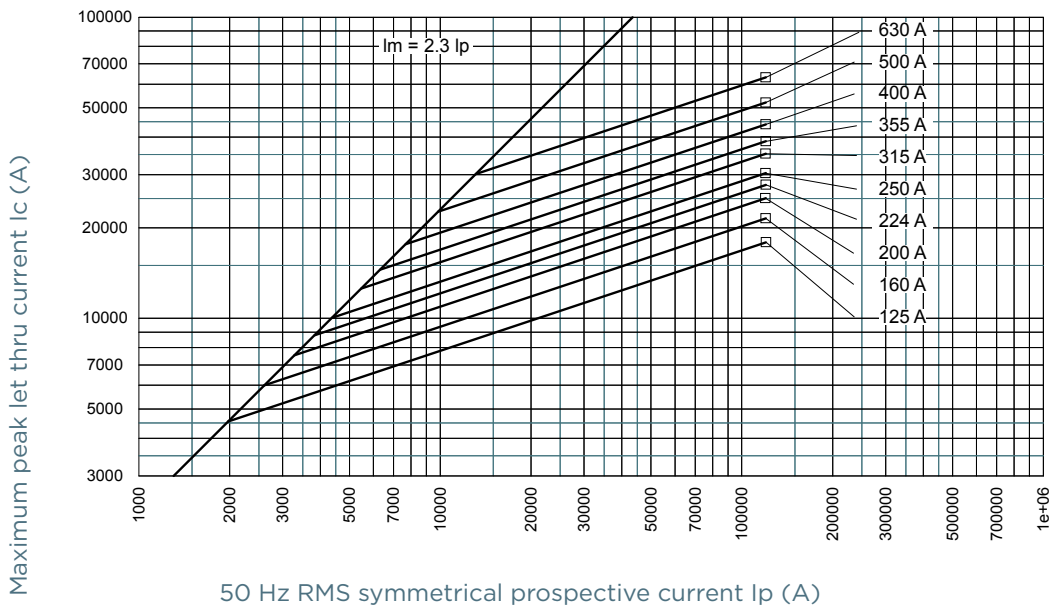

NH fuse-links gG 500 - 690VAC

with striker size 0, 1, 2, 3, 4

CUT-OFF CURRENT CHARACTERISTIC

Size 4, 500V gG

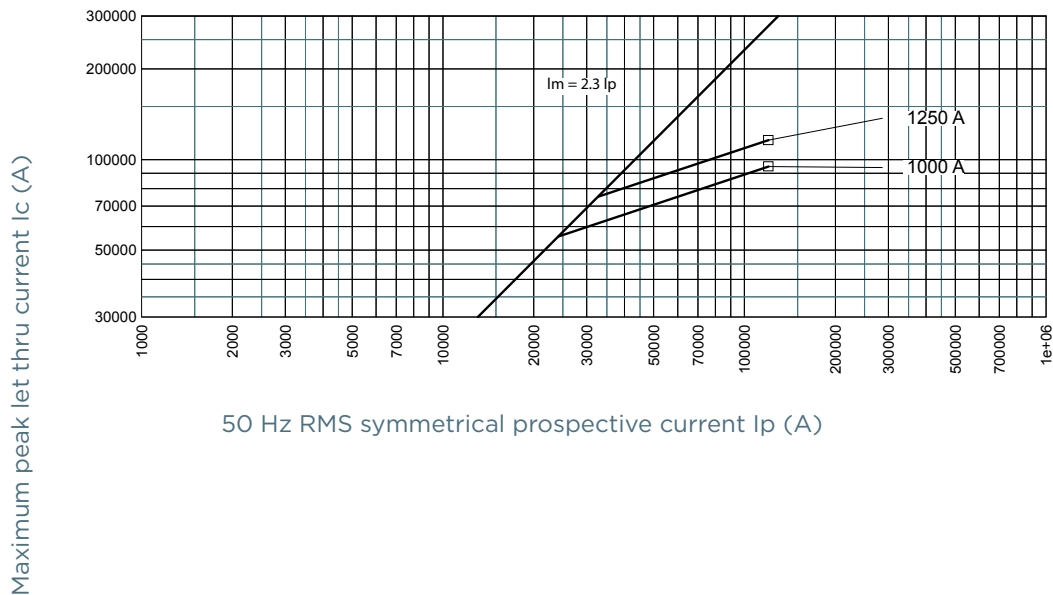

NH fuse-links gG 500 - 690VAC

with striker size 0, 1, 2, 3, 4

PRE-ARCING AND OPERATING I²t CHARACTERISTICS

Size 0-1-2-3, 690V gG

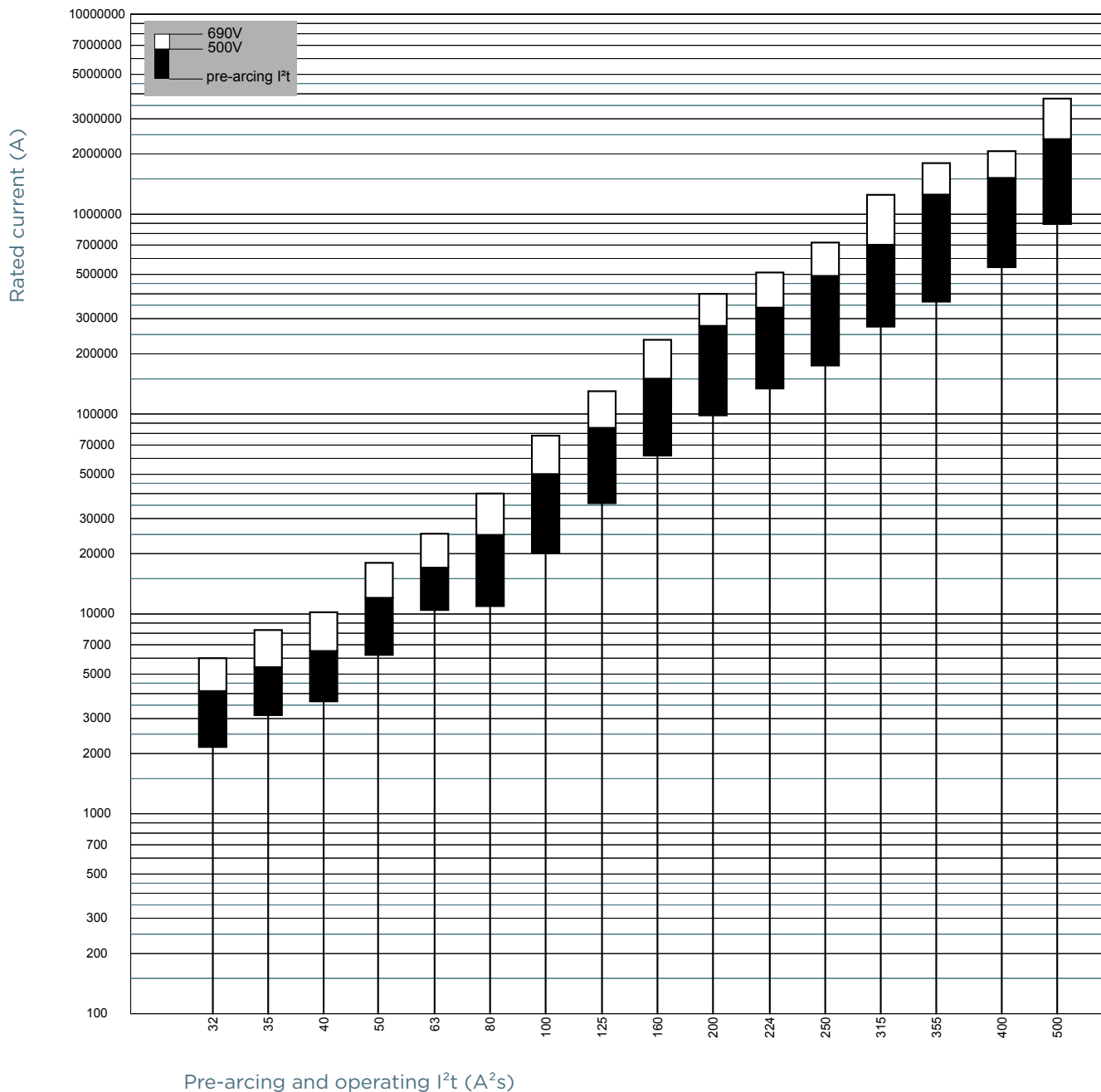

MERSEN reserves the right to change, update or correct, without notice, any information contained in this datasheet.

NH fuse-links gG 500 - 690VAC

with striker size 0, 1, 2, 3, 4

PRE-ARCING AND OPERATING I²t CHARACTERISTICS

Size 4, 690V gG

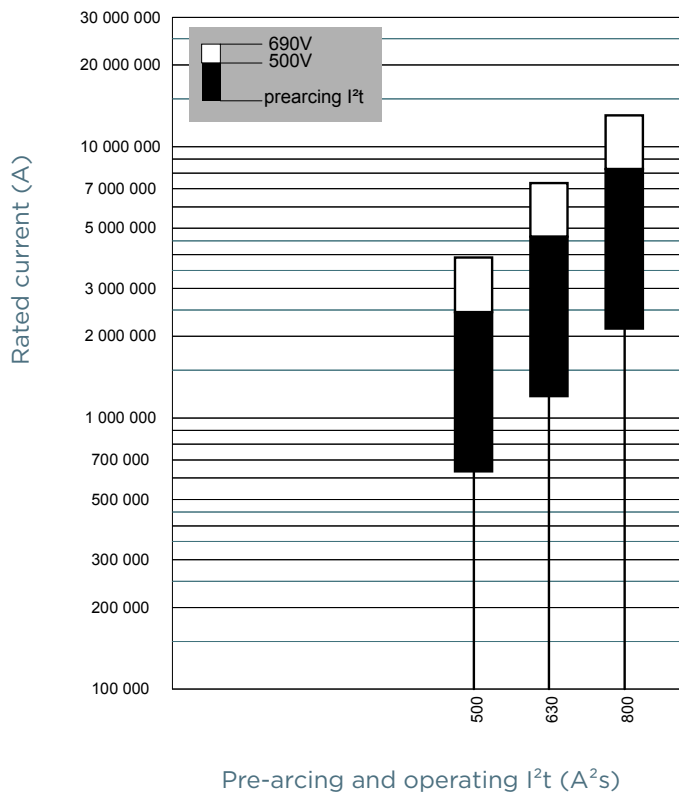

NH fuse-links gG 500 - 690VAC

with striker size 0, 1, 2, 3, 4

PRE-ARCING AND OPERATING I²T CHARACTERISTICS

Size 0-1-2-3, 500V gG

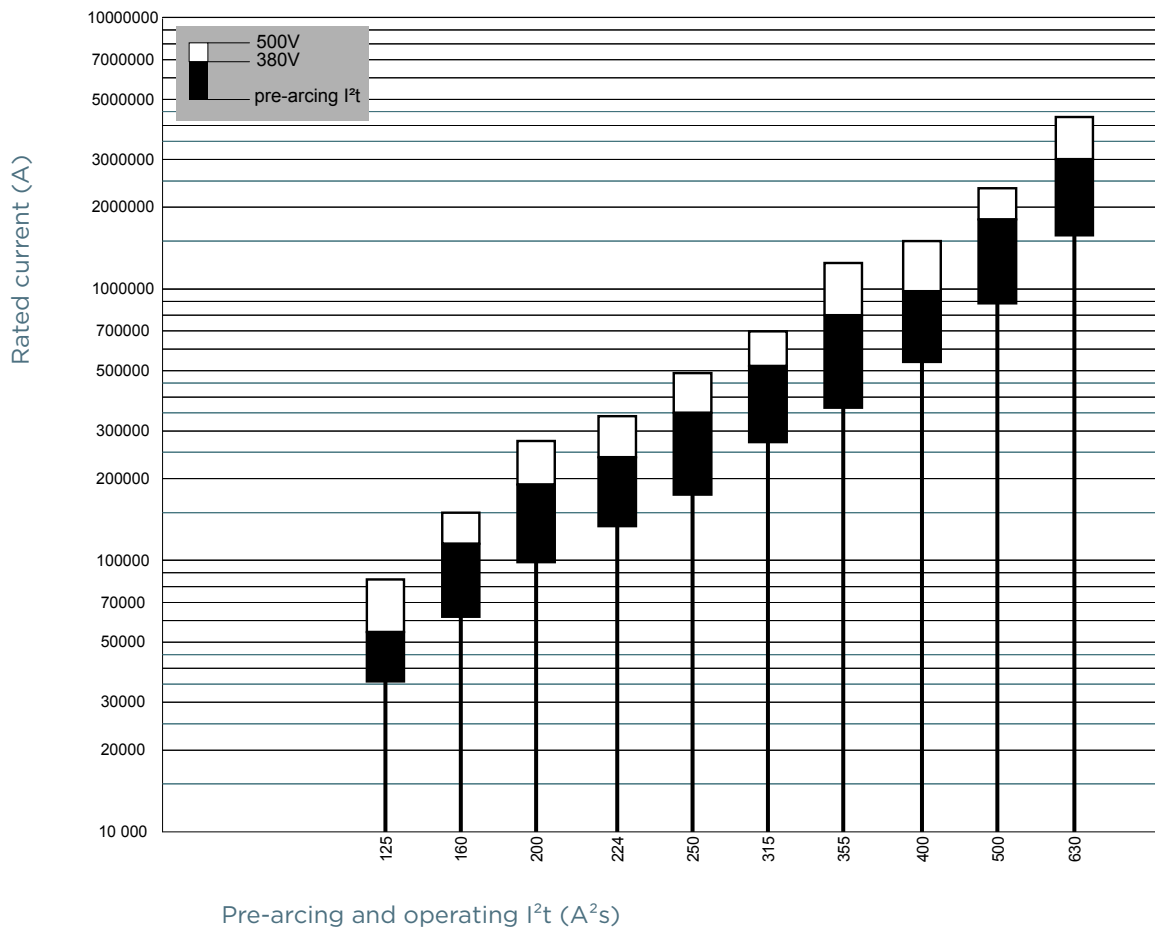

MERSEN reserves the right to change, update or correct, without notice, any information contained in this datasheet.

NH fuse-links gG 500 - 690VAC

with striker size 0, 1, 2, 3, 4

PRE-ARCING AND OPERATING I²T CHARACTERISTICS

Size 4, 500V gG

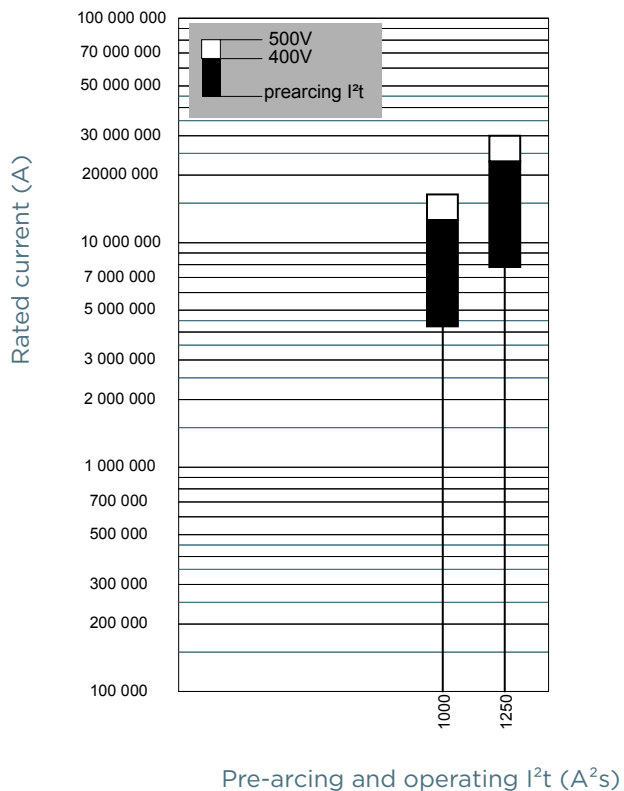

NH fuse-links gG 500 - 690VAC

with striker size 0, 1, 2, 3, 4

DIMENSIONS

Size 0 (1064083)

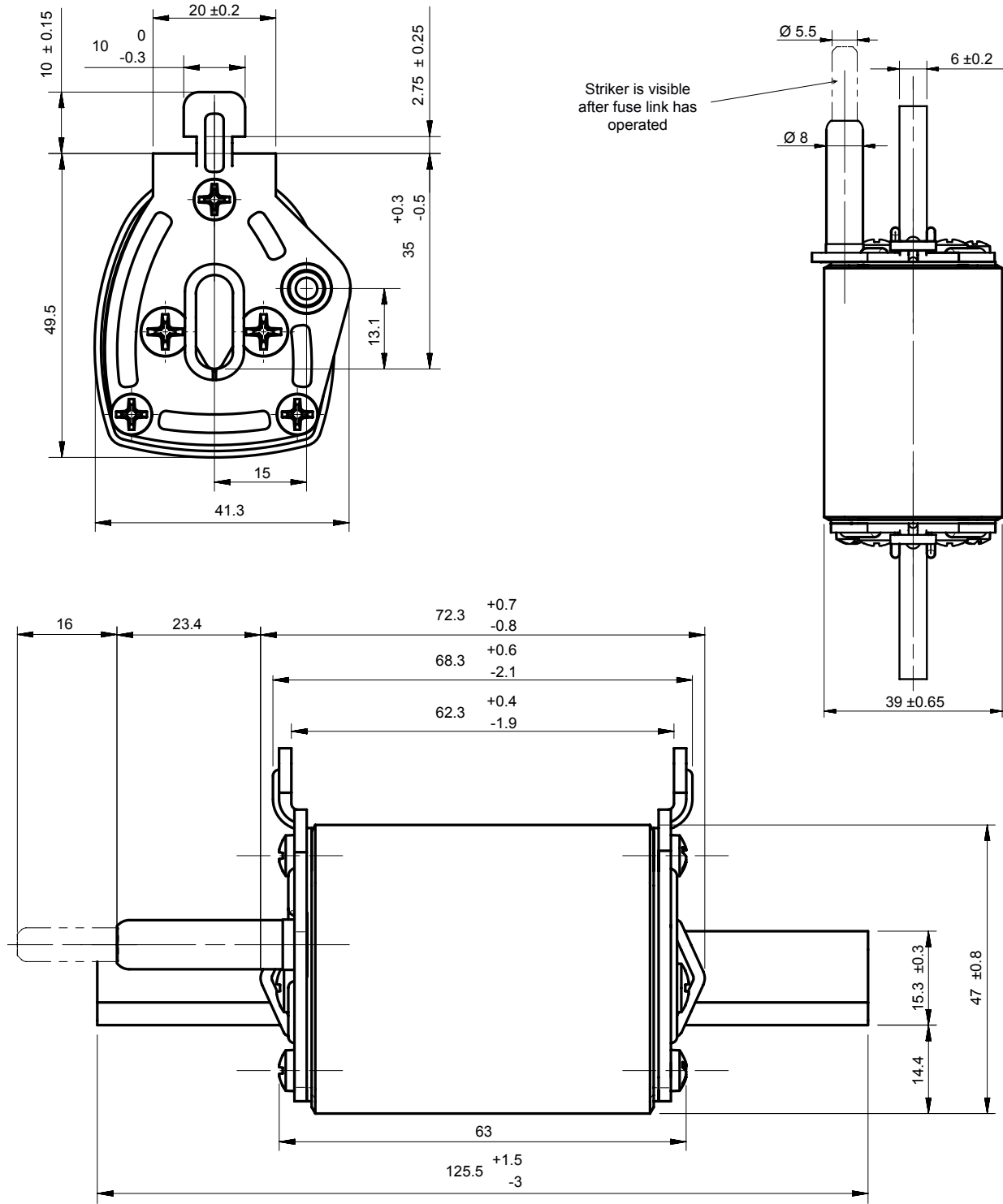

Dimensions in mm

Size 1

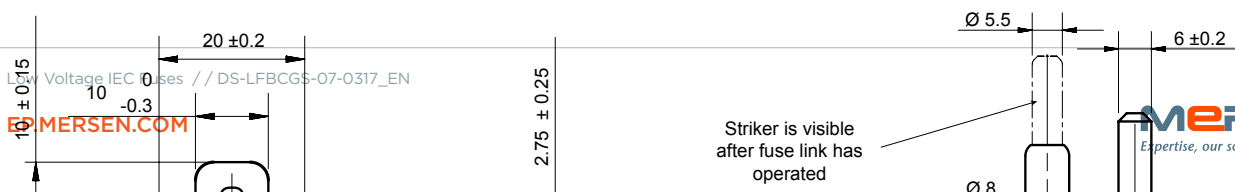

Low Voltage IEC fuses // DS-LFBCGS-07-0317_EN

MERSEN.COM

MERSEN
Expertise, our source of energy