

# MULTIVERT® 630A

Size 3, 690VAC

## IEC FUSE SWITCH DISCONNECTORS

### NH VERTICAL FUSE SWITCH DISCONNECTOR



MULTIVERT® NH vertical fuse switch disconnectors meet all functions of NH fuse switch disconnectors. They are designed for installation on to bus bars in triple pole arrangements.

MULTIVERT® 630A are for installation on to 185mm bus bar systems.

MULTIVERT® 630A are designed for NH fuse-links in accordance with IEC/EN 60269-2, VDE 0636-2, size 3: 630A.

The system is a modular system, that allows the installation of individual components. MULTIVERT® offer the user the possibility of fast and easy installation as well as a high degree of protection during installation and maintenance.

## TECHNICAL DATA OVERVIEW

Voltage AC	690 VAC
Amper (A)	630 A
Size per Standard	3
SCCR	Ue = AC 400 V; Ie = 630 A 80kA Ue = AC 500 V; Ie = 630 A 80kA Ue = AC 690 V; Ie = 500 A 80kA
Mounting	bus bar system 185 mm
Switchability	1 x triple pole, 3 x single pole
Number of Poles	3

## FEATURES & BENEFITS

- Installation on to 185mm bus bar system  
Standard design with M 12 screws:  $M = 35 \pm 3Nm$   
Direct installation without drilling with hooked clamps possible
- Symmetrical switch - top/bottom cable terminal connection
- Touch protection IP 30 with central cover
- Varieties of cable termination: bolt, insert nut, V-terminal
- Integrated measuring transformer (optional) with unchanged installation depth
- Safe on load connection/disconnection in accordance with IEC 60947-3

## APPLICATIONS

- Feeder pillars
- Transformer substations
- Switch boards for industrial applications
- Residential and industrial distribution units
- Cable distribution cabinets

## STANDARDS

- IEC/EN 60 947-3  
For NH-fuse links size 3 in accordance with IEC/EN 60 269-2, VDE 0636-2



# MULTIVERT® 630A

Size 3, 690VAC

## PRODUCT RANGE



1.350.000 1.370.000

### MULTIVERT® 630 A size 3 185 mm 1 x triple pole switching

Catalog number	Item number	Cable termination components	Design	Weight kg <sup>1</sup>	Package
1.350.000	N1002191	3 M12 bolts	-	5.59	1 piece
1.360.000	C1023249	3 M12 insert nuts	-	5.52	1 piece
1.370.000	D1023250	V-terminal for V-terminal clamps size 1,2,3	-	5.39	1 piece
1.370.900	F1023252	V-terminal, 2 terminals per phase for V-terminal clamps size 1,2,3	-	7.05	1 piece
1.370.600	E1023251	V-terminal + 3 V-terminal clamps	-	5.63	1 piece
1.350.100	Y1002200	3 M12 bolts	MULTIVERT® 1.350.000 with cabling of instrument leads for indication facilities	6.10	1 piece
1.370.100	G1023253	V-terminal for V-terminal clamps size 1,2,3	MULTIVERT® 1.370.000 with cabling of instrument leads for indication facilities	5.90	1 piece
1.350.085	K1023256	3 M12 bolts	MULTIVERT® 1.350.000 with integrated C.T. 600/5A, 5,00 VA, class 1 for single pole measurement (ready fitted in pole 1)	5.80	1 piece
1.350.066	H1023254	3 M12 bolts	MULTIVERT® 1.350.000 with integrated C.T. 600/5A, 5,00 VA, class 0,5; calibrated, for single pole measurement (ready fitted in pole 1)	-	1 piece
1.350.095	L1023257	3 M12 bolts	MULTIVERT® 1.350.000 with integrated C.T. 600/5A, 5,00 VA, class 1 for triple pole measurement	6.50	1 piece
1.350.076	J1023255	3 M12 bolts	MULTIVERT® 1.350.000 with integrated C.T. 600/5A, 5,00 VA, class 0,5; calibrated, for triple pole measurement	-	1 piece
1.370.095	P1023260	V-terminal for V-terminal clamps size 1,2,3	MULTIVERT® 1.370.000 with integrated C.T. 600/5A, 5,00 VA, class 1 for triple pole measurement	6.00	1 piece
1.370.076	M1023258	V-terminal for V-terminal clamps size 1,2,3	MULTIVERT® 1.370.000 with integrated C.T. 600/5A, 5,00 VA, class 0,5; calibrated, for triple pole measurement	-	1 piece
1.380.000	R1023262	M12 bus bar terminal	MULTIVERT® with lateral bus bar terminals bus bar coupler switch cable terminal connection to right or left side possible	4.77	1 piece

<sup>1</sup>weight in kg per piece or set including package

MERSEN reserves the right to change, update or correct, without notice, any information contained in this datasheet.

# MULTIVERT® 630A

Size 3, 690VAC

## PRODUCT RANGE

### MULTIVERT® 630 A size 3 185mm 3 x single pole switching



1.300.000 1.320.000

Catalog number	Item number	Cable termination components	Design	Weight kg <sup>1</sup>	Package
1.300.000	K1002188	3 M12 bolts	-	5.43	1 piece
1.310.000	W1023220	3 M12 insert nuts	-	5.38	1 piece
1.320.000	X1023221	V-terminal for V-terminal clamps size 1,2,3	-	5.21	1 piece
1.320.900	Y1023222	V-terminal, 2 terminals per phase for V-terminal clamps size 1,2,3	-	6.89	1 piece
1.300.100	W1027153	3 M12 bolts	MULTIVERT® 1.200.000 with cabling of instrument leads for indication facilities	5.10	1 piece
1.300.085	A1023247	3 M12 bolts	MULTIVERT® 1.300.000 with integrated C.T. 600/5A, 5,00 VA, class 1 for single pole measurement (ready fitted in pole 1)	5.60	1 piece
1.300.066	Z1023223	3 M12 bolts	MULTIVERT® 1.300.000 with integrated C.T. 600/5A, 5,00 VA, class 0,5; calibrated, for single pole measurement (ready fitted in pole 1)	-	1 piece
1.300.095	B1023248	3 M12 bolts	MULTIVERT® 1.300.000 with integrated C.T. 600/5A, 5,00 VA, class 1 for triple pole measurement	6.30	1 piece
1.300.076	Z1023246	3 M12 bolts	MULTIVERT® 1.300.000 with integrated C.T. 600/5A, 5,00 VA, class 0,5; calibrated, for triple pole measurement	-	1 piece
1.330.000	Q1023261	M12 bus bar terminal	MULTIVERT® with lateral bus bar terminals bus bar coupler switch cable terminal connection to right or left side possible	6.10	1 piece

<sup>1</sup>weight in kg per piece or set including package

MERSEN reserves the right to change, update or correct, without notice, any information contained in this datasheet.

# MULTIVERT® 630A

Size 3, 690VAC

## TECHNICAL DATA IN ACCORDANCE WITH EN / IEC 60947

	<b>630 A</b> <b>1 x triple pole switching</b>	<b>630 A</b> <b>3 x single pole switching</b>
Number of poles/phases	3	3
Size	3	3
Conventional free air thermal current with NH-fuse links $I_{th}$	630 A	630 A
Max. power dissipation of fuse links $P_n$	48 W	48 W
Conventional free air thermal current with solid links $I_{th}$	800 A	800 A
Max. power dissipation of solid links $P_n$	17,5 W	17,5 W
Utilization category to IEC/EN 60947-3 $U_e = AC 400 V; I_e = 630 A$ $U_e = AC 500 V; I_e = 630 A$ $U_e = AC 690 V; I_e = 630 A$	AC 23 B AC 22 B AC 21 B	AC 23 B AC 22 B AC 21 B
Rated operational voltage $U_e$	690 V	690 V
Rated insulation voltage $U_i$	1000 V	1000 V
Rated impulse withstand voltage $U_{imp}$	12 kV	12 kV
Rated frequency	50 ... 60 Hz	50 ... 60 Hz
Degree of protection	IP 30	IP 30
Degree of pollution	3	3
Rated duty	uninterrupted duty	uninterrupted duty
Rated conditional short-circuit current with fuse links $U_e = AC 400 V; I_e = 630 A$ $U_e = AC 500 V; I_e = 630 A$ $U_e = AC 690 V; I_e = 500 A$	80 kA 80 kA 80 kA	80 kA 80 kA 80 kA
Rated short circuit making capacity with solid links $I_{cm}$	16 kA <sub>sw</sub>	16 kA <sub>sw</sub>
Rated short-time withstand current $I_{cw}$	12.6 kA / 1 s	12.6 kA / 1 s
Power dissipation by $I_{th}$ without NH-fuse links	95 W	95 W
Power dissipation by $I_{th}$ 800A without solid links	153 W	153 W
Installation mode	bus bar installation	bus bar installation
<b>Cable terminal connection</b>		
Standard cable terminal	M12	M12
for cable lugs Cu max.	300 mm <sup>2</sup>	300 mm <sup>2</sup>
for cable lugs Al max.	300 mm <sup>2</sup>	300 mm <sup>2</sup>
for copper bars with max. dimensions	40 x 10 mm	40 x 10 mm
V-shaped lugs for V-terminal clamps	35 - 240 mm <sup>2</sup>	35 - 240 mm <sup>2</sup>
<b>Bus bar terminal connection</b>		
Standard bus bar terminal	M12	M12
Hooked clamp for bus bar with thickness	5 ... 10 mm	5 ... 10 mm
Bus bar system	185 mm	185 mm

MERSEN reserves the right to change, update or correct, without notice, any information contained in this datasheet.

# MULTIVERT® 630A

Size 3, 690VAC

## DIMENSIONS

### MULTIVERT® 250A, 400A, 630A NH-vertical fuse switch disconnecter, 3 x single pole switching direct installation with screws on to 185mm bus bar system

(M01152b)

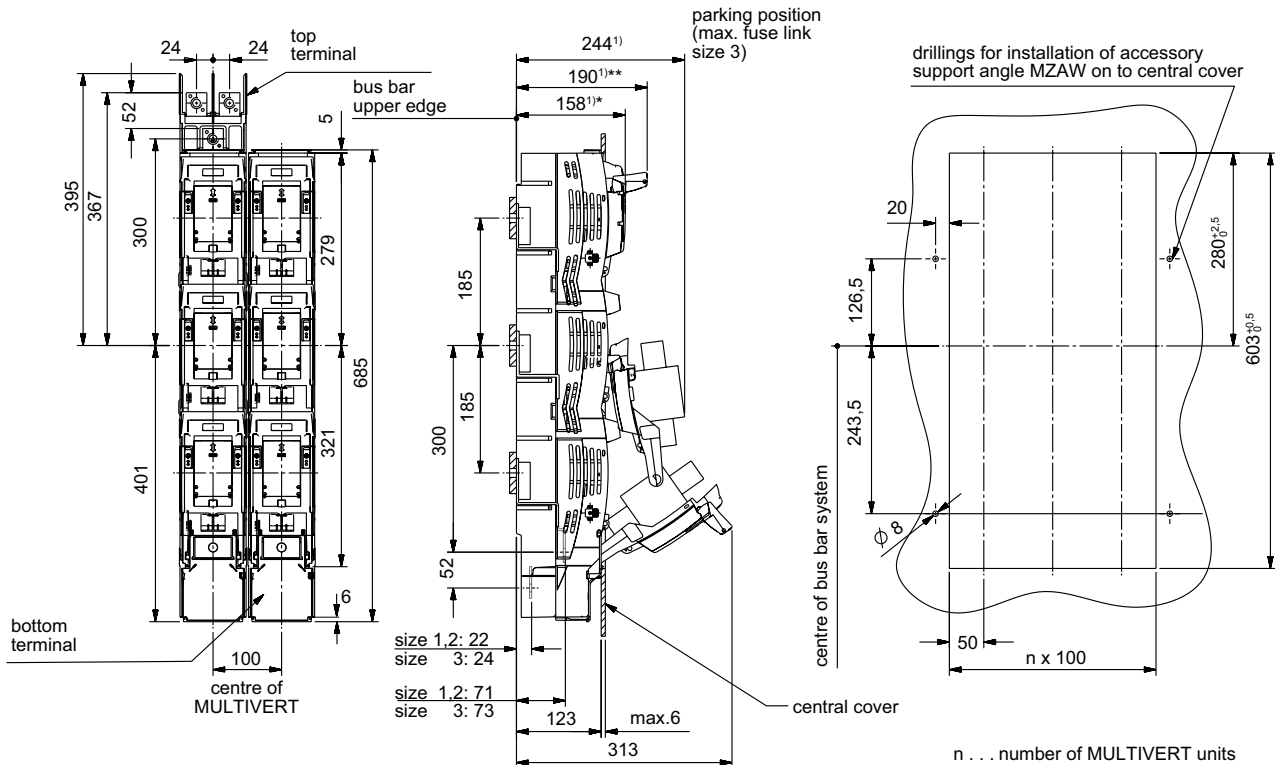

1) dimension from upper edge of bus bar

- \* 158 mm handle in closed position (folded) = total installation depth of MULTIVERT
- \*\* 190 mm handle in open position (fixed) = switching position

Dimensions in mm

### MULTIVERT® 250A, 400A, 630A NH-vertical fuse switch disconnecter, 1 x triple pole switching direct installation with screws on to 185mm bus bar system

(M01153b)

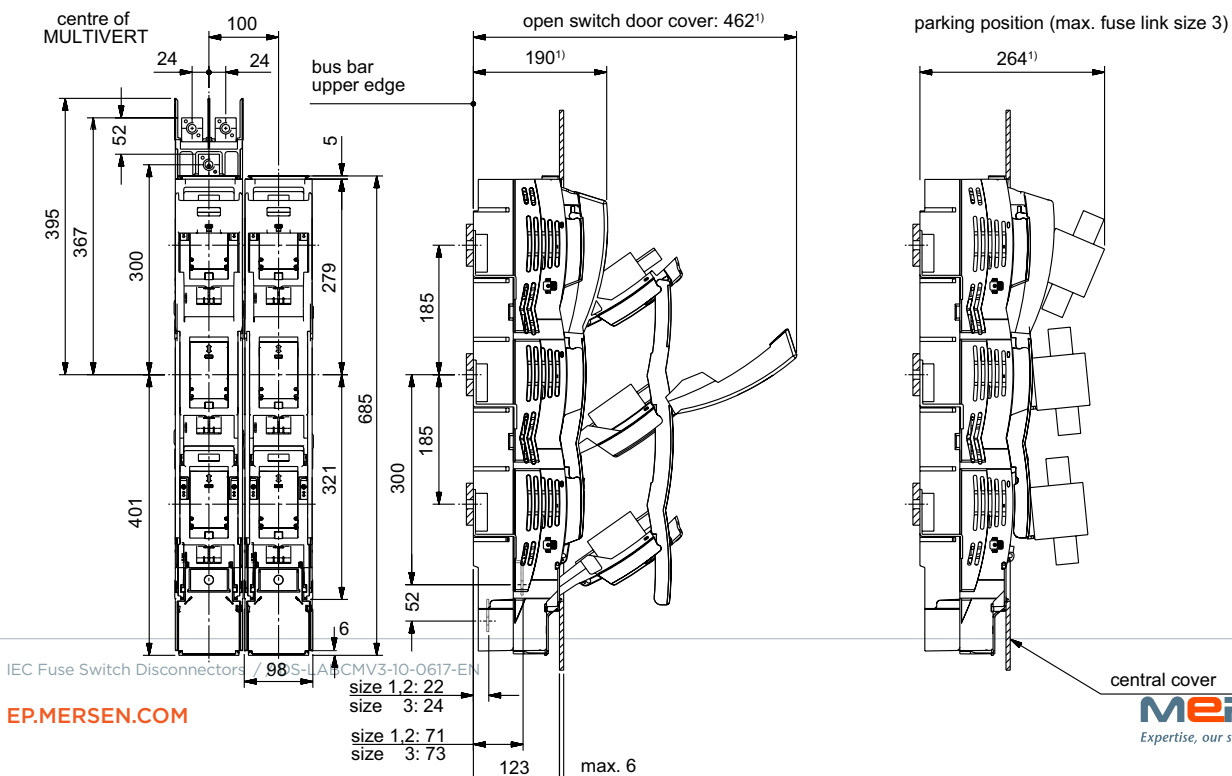

# MULTIVERT® 630A

Size 3, 690VAC

## DIMENSIONS

**MULTIVERT® 250A, 400A, 630A NH-vertical fuse switch disconnecter, 3 x single pole switching**  
**direct installation without drilling with hooked clamps on to 185mm bus bar system**

(M01154b)

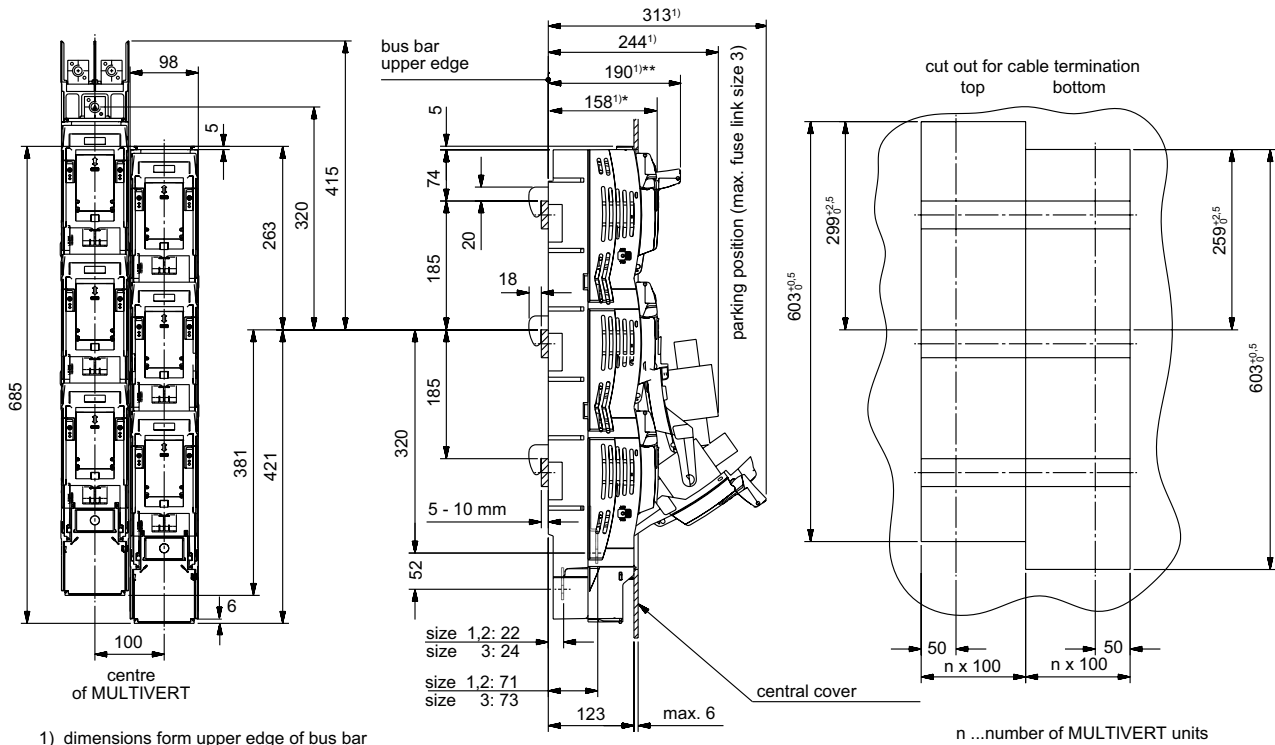

1) dimensions form upper edge of bus bar

\* 158 mm handle in closed position (folded) = total installation depth of MULTIVERT

\*\* 190 mm handle in open position (fixed) - switching position

Dimensions in mm

# MULTIVERT® 630A

Size 3, 690VAC

## DIMENSIONS

**MULTIVERT® 250A, 400A, 630A bus bar coppler switch with lateral terminals**  
**3 x single pole switching**

(M01159a)

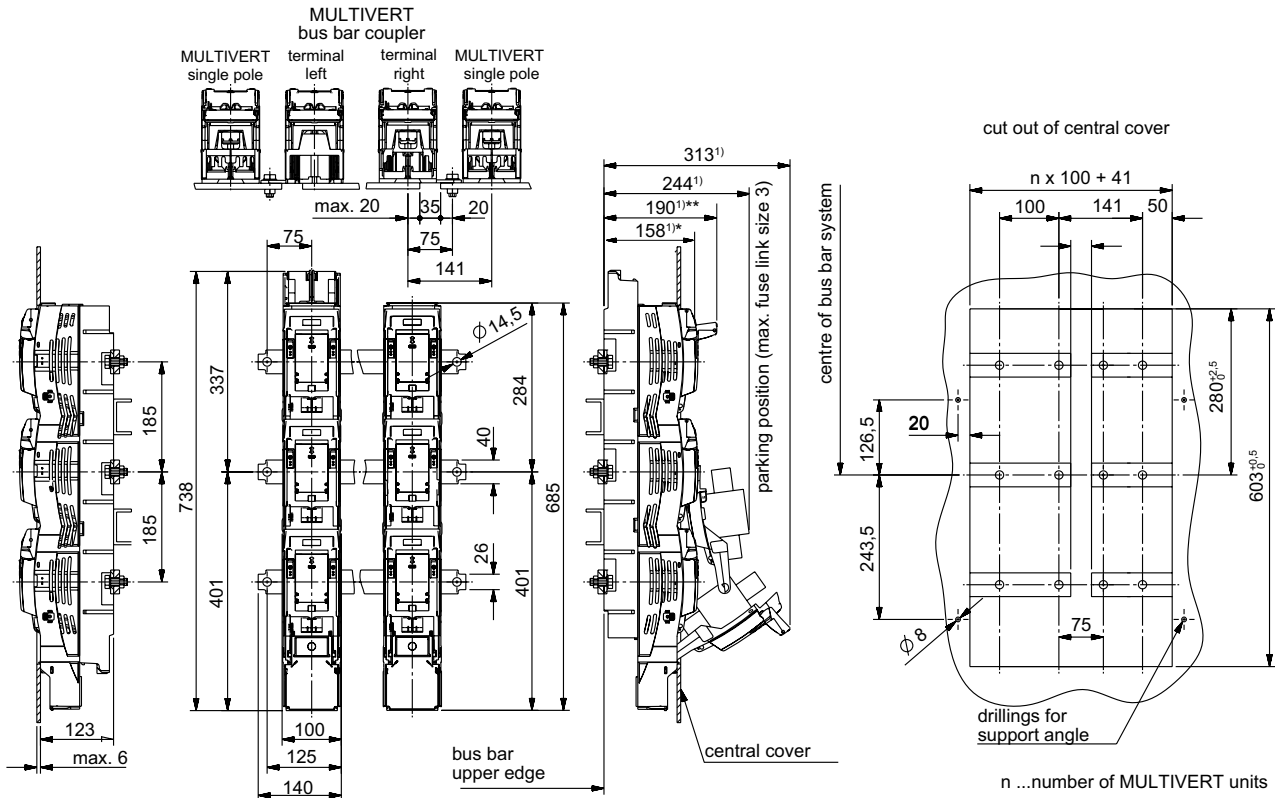

1) dimensions form upper edge of bus bar

\* 158 mm handle in closed position (folded) = total installation depth of MULTIVERT  
 \*\* 190 mm handle in open position (fixed) - switching position

Dimensions in mm

# MULTIVERT® 630A

Size 3, 690VAC

## DIMENSIONS

### Cable termination MULTIVERT® 250A, 400A, 630A (M01105b)

reference	B	E	V	
type of terminal	bolt	insert nut	V-terminal	
accessory	cable lug max. width 45 mm	cable lug max. width 45 mm	V-clamp (accessory)	
cross section [mm²]	max. 300	max. 300	22SZVK4 50 - 240 sectoral solid 50 - 185 sectoral stranded 35 - 70 round stranded 35 - 50 round solid	22SZVK41 95 - 300 sectoral solid 70 - 240 sectoral stranded 50 - 185 round stranded 70 - 240 round solid
M [Nm]	35 ±3	35 ±3	25 ±2	25 ±2

Dimensions in mm



# MULTIVERT® 630A

Size 3, 690VAC

## DIMENSIONS

Cable termination MULTIVERT® 250A, 400A, 630A multiple termination (M01156a)

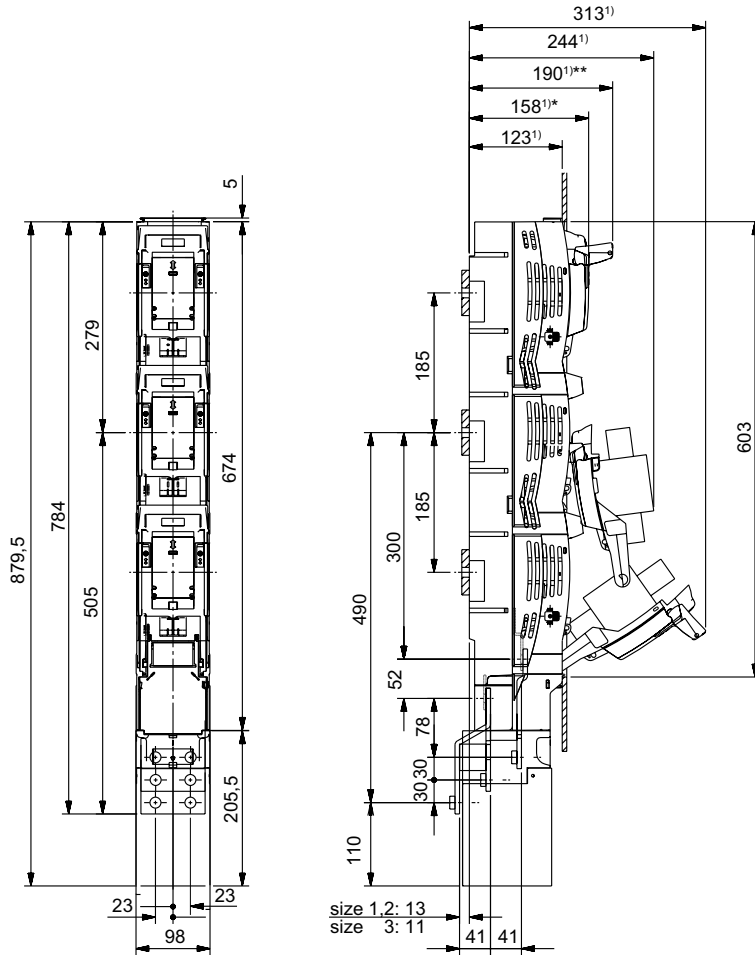

1) dimensions form upper edge of bus bar

- \* 158 mm handle in closed position (folded) = total installation depth of MULTIVERT
- \*\* 190 mm handle in open position (fixed) - switching position

Dimensions in mm

# MULTIVERT® 630A

Size 3, 690VAC

## DIMENSIONS

### Cable termination MULTIVERT® 250A, 400A, 630A multiple termination (MA88f)

terminal: 2 cable lugs

Cu: up to max. 300 mm<sup>2</sup> round stranded, sectoral stranded cable lugs in accordance with DIN 46235  
 Al: up to max. 300 mm<sup>2</sup> round stranded, sectoral stranded cable lugs in accordance with DIN 46329  
 M: 32-38 Nm

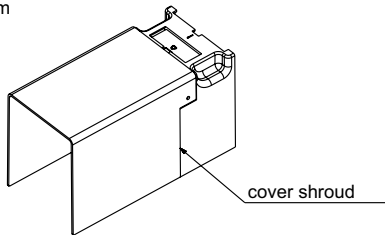

cable lugs in accordance with DIN 46235 and DIN 46329 max. width 46 mm

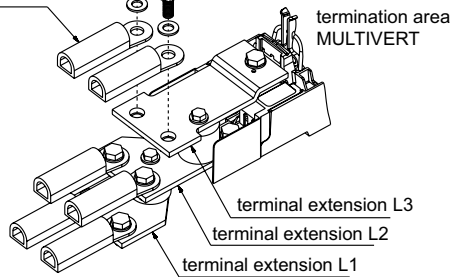

NOTE:  
 Due to safety precautions we suggest to insulate the cable lugs (185, 240 und 300 mm<sup>2</sup>).

terminal: 3 cable lugs

Cu: up to max. 150 mm<sup>2</sup> round stranded, sectoral stranded cable lugs in accordance with DIN 46235  
 M: 32-38 Nm

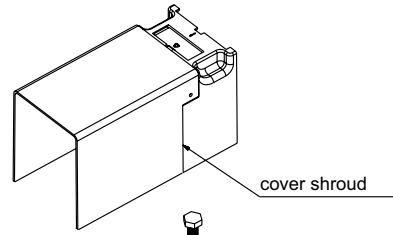

cable lug in accordance with DIN 46235

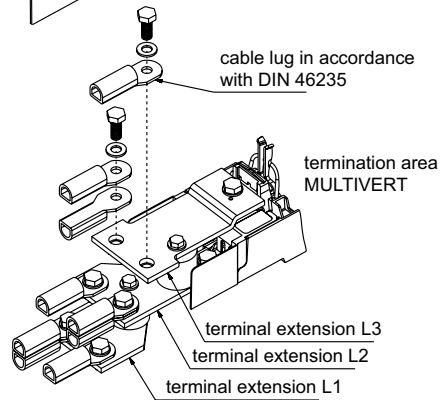

NOTE:  
 Due to safety precautions we suggest to insulate the cable lugs (95, 120 und 150 mm<sup>2</sup>).

Position of terminals

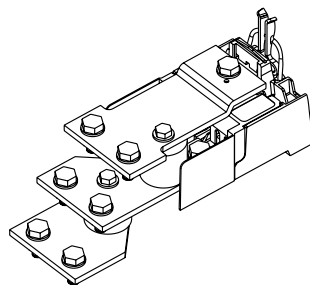

tightening torque of screws: 32 - 38 Nm

Dimensions in mm

# MULTIVERT® 630A

Size 3, 690VAC

## DIMENSIONS

### Cover shrouds for cable termination bottom terminal MULTIVERT® 250A, 400A, 630A (M01160a-1)

#### standard design: integrated shroud for bottom cable termination

for terminal connections with cable lugs (bolt and insert nut)  
- on switch boards with central cover

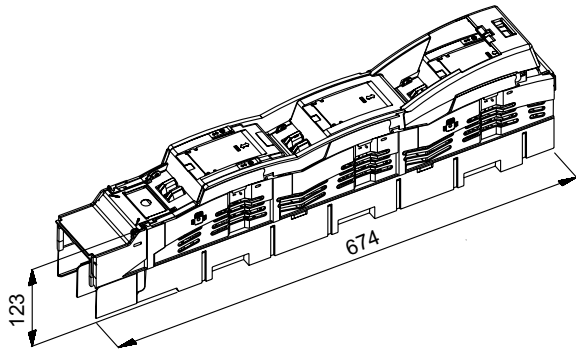

for clamp terminal connections (V-terminal)  
for special "high" clamp terminal connections (double V-clamps)  
- on switch boards with central cover  
and in feeder pillars

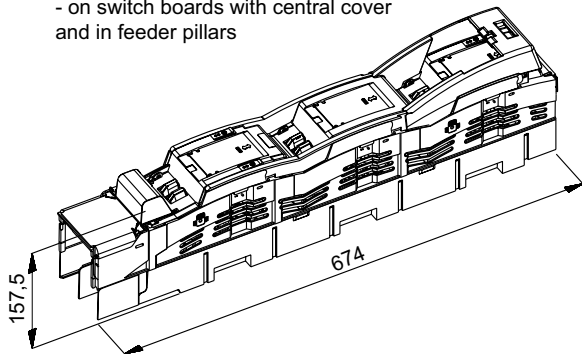

#### Extension shroud for bottom cable termination article number 1.002.095 (accessory)

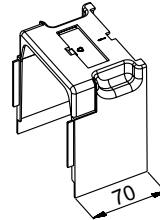

for extended cover  
for terminal connections with cable lugs (bolt and insert nut)  
- on switch boards with central cover

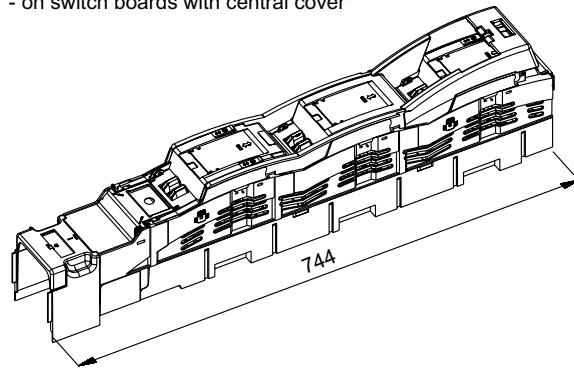

for extended cover  
for clamp terminal connections (V-terminal)  
for special "high" clamp terminal connections (double V-clamps)  
- on switch boards with central cover  
and in feeder pillars

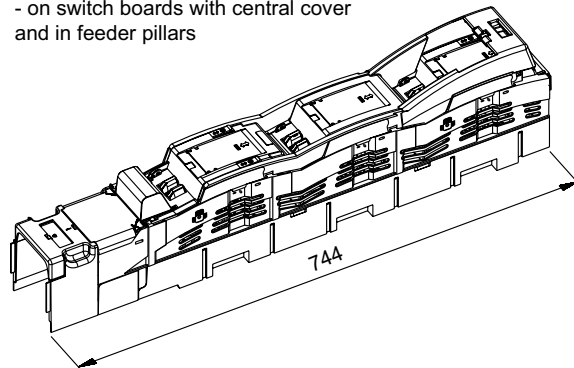

Dimensions in mm

# MULTIVERT® 630A

Size 3, 690VAC

## DIMENSIONS

**Cover shrouds for cable termination bottom terminal MULTIVERT® 250A, 400A, 630A multiple termination**

(M01160b-2)

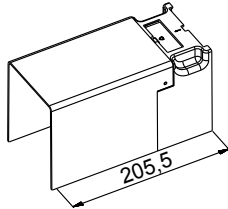

catalogue no. 1.002.458 - accessory

for application multiple termination  
for cable termination with 2 or 3 cable lugs/phase  
see MA 88  
- on switch boards with cover shroud

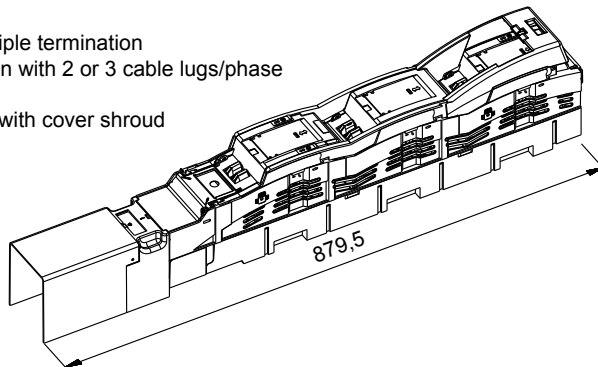

for application multiple termination  
for V-terminal: terminal lugs: 2 terminals per phase with V-clamp  
- on switch boards with central cover  
and in feeder pillars

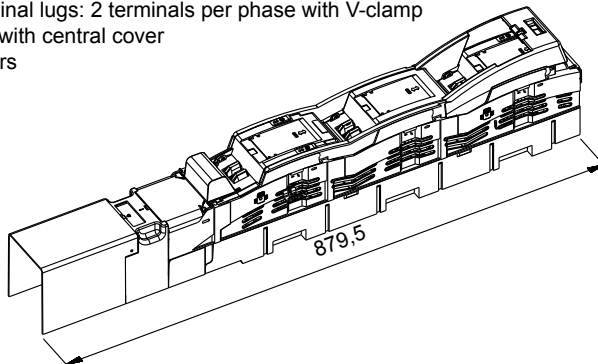

Dimensions in mm

MERSEN reserves the right to change, update or correct, without notice, any information contained in this datasheet.

# MULTIVERT® 630A

Size 3, 690VAC

## DIMENSIONS

Cover shrouds for cable termination top terminal MULTIVERT® 250A, 400A, 630A (M01160a-3)

without shroud for cable termination

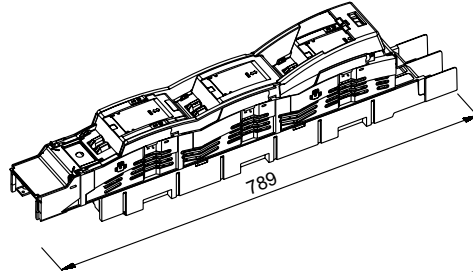

shroud for top cable termination  
article number: MZKHO (accessory)  
for terminal connections with  
cable lugs (bolt and insert nut)  
- on switch boards with central cover

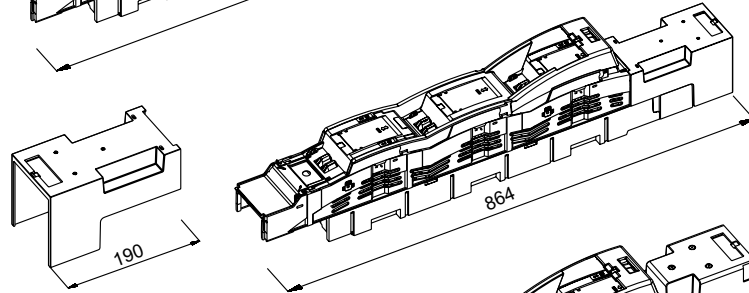

shroud for top cable termination  
article number: MZKAB (accessory)  
for clamp terminal connections  
(V-terminal)  
- in feeder pillars

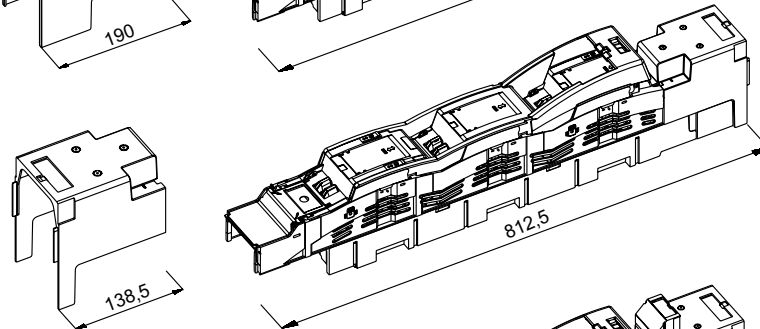

shroud for top cable termination  
article number: MZKAB1 (accessory)  
for special "high" clamp terminal  
connections (double V-clamps)  
- in feeder pillars

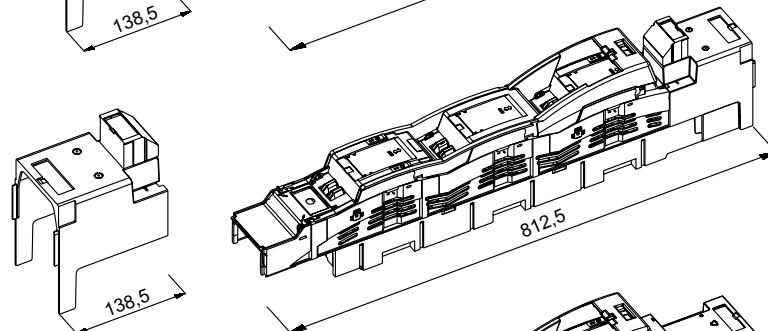

shroud for top cable termination  
article number: MZKHV (accessory)  
for terminal connections with cable lugs  
for installation in distribution units  
with central cover

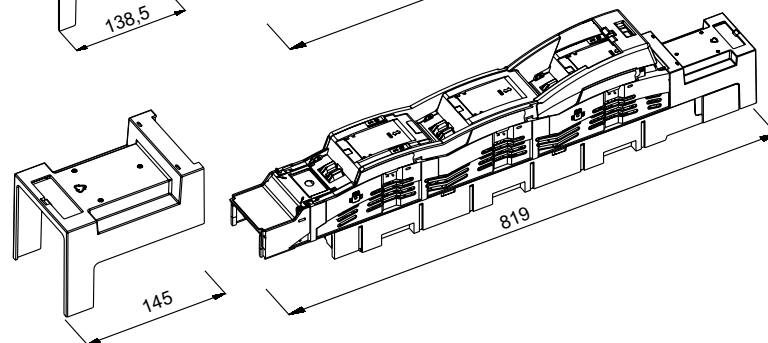

Dimensions in mm

MERSEN reserves the right to change, update or correct, without notice, any information contained in this datasheet.

# MULTIVERT® 630A

Size 3, 690VAC

## EXPLODED SKETCH

MULTIVERT® 250A, 400A, 630A 3x single pole switching (E 1.002.265a)

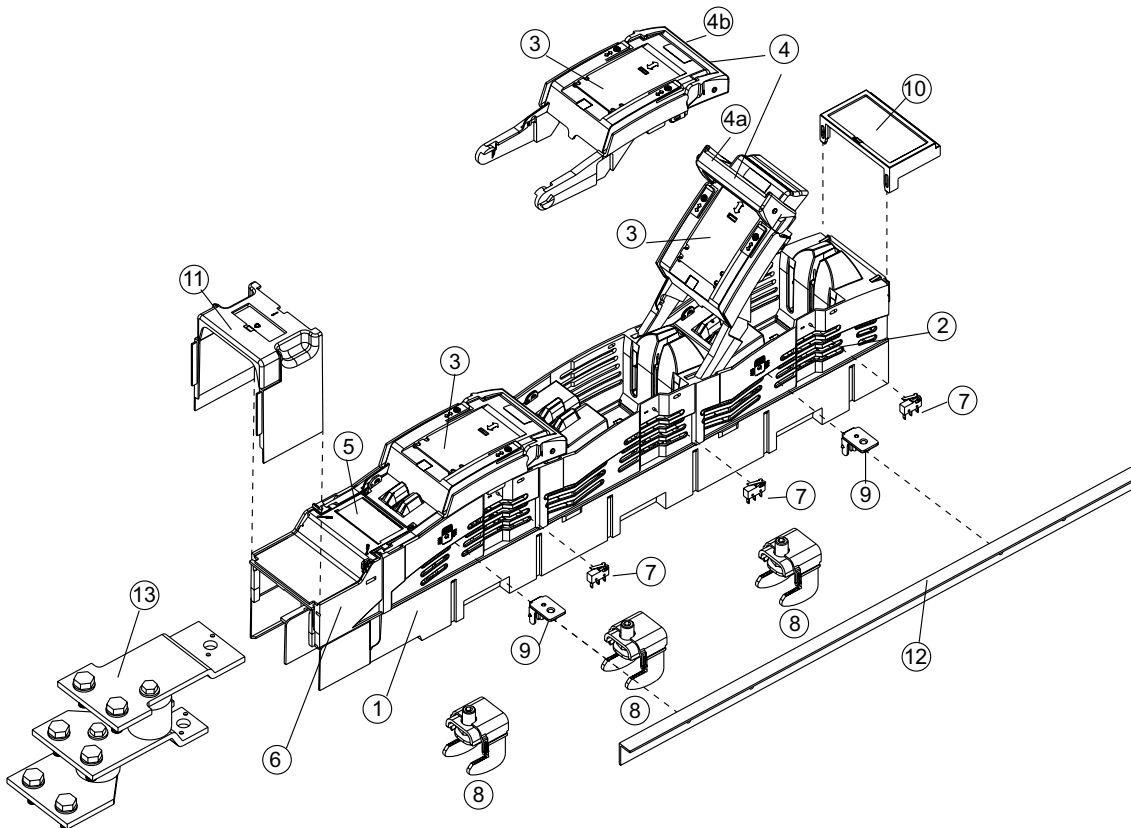

no.	articlenumber	short Description
1		Main base
2		Protection cover (removable)
3		Switch operating cover triple pole
4		Combination handle: 4a. open - switching position; 4b. Closed - installation depth 158mm
5		Labelling area (label)
6		Integrated cover shroud
7	1.000.852	indicator for switch door position
8	1.000.192	Hooked clamp, 1 set = 3 pieces
9	MZAW	Support angle, 1 set = 4 pieces
10	MZBT	Label holder
11	1.002.095	Cover shroud, bottom terminal, 70mm
12	1.001.510	cover shield, length 605mm, set=2 pieces
13	1.002.255	Supplementary set for multiple terminal

# MULTIVERT® 630A

Size 3, 690VAC

## EXPLODED SKETCH

MULTIVERT® 250A, 400A, 630A 1x triple pole switching (E 1.002.266)

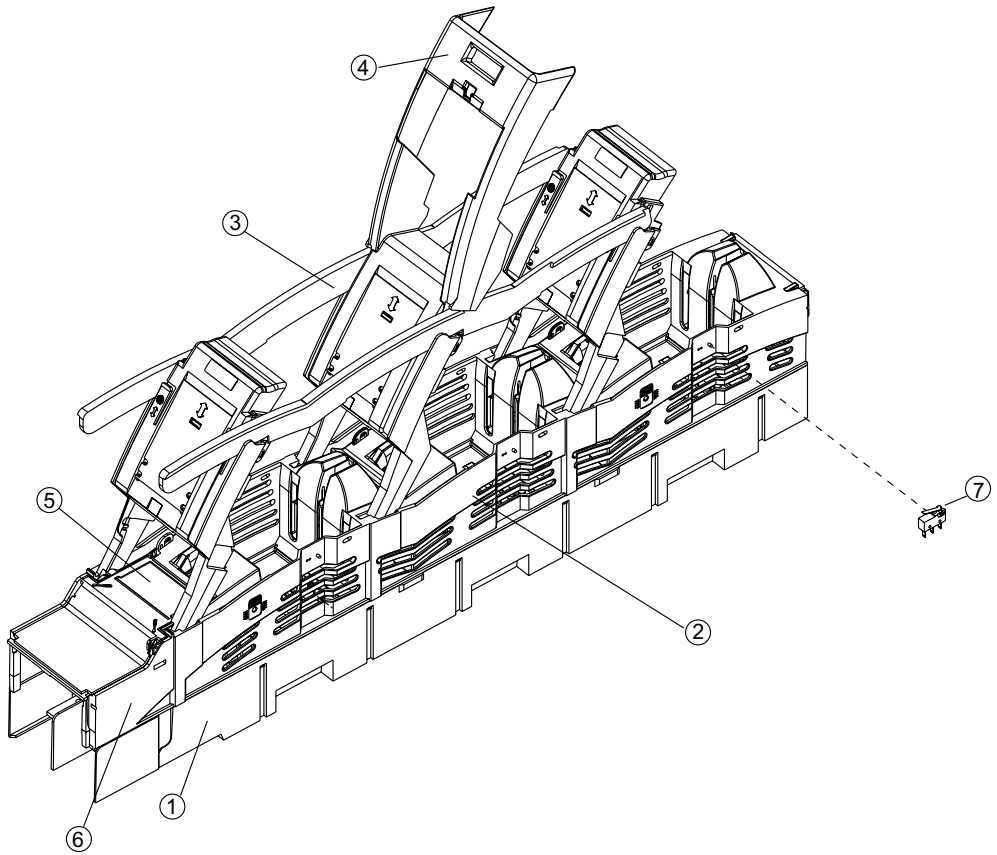

no.	articlenumber	short Description
1		Main base
2		Protection cover (removable)
3		Switch operating cover triple pole
4		Handle
5		Labelling area (label)
6		Integrated cover shroud
7	1.000.852	indicator for switch door position

# MULTIVERT® 630A

Size 3, 690VAC

## ACCESSORIES



1.002.095



1.002.458



MZKAB



MZKHO



MZKAB1



MZVHB



MZKHV



1.001.510



MZAW

### Cover/shrouds for cable termination

Catalog number	Item number	Weight	Design	Appli- cation	Weight	Package
1.002.095	J1002279	0.116 kg	cover shroud for extended cover length 70 mm	bottom terminal	0.116 kg	1 piece
1.002.458	N1023305	0.164 kg	cover shroud for multiple termination length 205,5mm	bottom terminal	0.164 kg	1 piece
MZKAB	J1023301	0.174 kg	cover shroud for clamp terminal connection in feeder pillars length 138,5 mm	top terminal	0.101 kg	1 piece
MZKHO	G217655	0.126 kg	cover shroud for cable terminal connections with cable lugs on switchboards with central cover length 190 mm	top terminal	0.126 kg	1 piece
MZKAB1	K1023302	0.115 kg	cover shroud for special (high) clamp terminal connection in feeder pillars length 138,5 mm	top terminal	0.115 kg	1 piece
MZVHB	L1023303	0.225 kg	extended cover shroud length 257 mm	top terminal	0.225 kg	1 piece
MZKHV	A1002202	85 g	cover shroud for installation in distribution units with central cover (height of supporting edge reduced by 16 mm) length 145 mm	top terminal	85 g	1 piece

### Covers/level & system adjustment covers

Catalog number	Item number	Weight	Design	Weight	Package
1.001.510	K1002280	0.15 kg	cover shield to support central cover 1 set = 2 pieces	0.15 kg	1 set
MZAW	D218687	27 g	support angle for support of cover plate 1 set = 4 pieces	0.027 kg	1 set

MERSEN reserves the right to change, update or correct, without notice, any information contained in this datasheet.



## ACCESSORIES



MZO1LPAP MZLPAP 1.002.493



1.002.492 1.002.830 1.002.829



1.002.648



1.000.192

### Covers/spare way covers

Catalog number	Item number	Weight	Design	Application	Weight	Package
MZO1LPAP	C1023410	60 g	spare way cover without level adjustment width 50 mm, length 500 mm including fixing material	bus bar system 185 mm	60 g	1 piece
MZLPAP	D1023411	0.56 kg	spare way cover width 100 mm, length 612 mm including 2 pieces M12 fixing screws (distance of fixing holes 185 mm)	bus bar system 185 mm	0.56 kg	1 piece
1.002.493	N1002283	0.136 kg	spare way cover width 50 mm, length 630 mm for covering of open installation spaces in distribution units with central cover	bus bar system 185 mm	0.136 kg	1 piece
1.002.492	M1002282	0.202 kg	spare way cover width 100 mm, length 630 mm for covering of open installation spaces in distribution units with central cover	bus bar system 185 mm	0.202 kg	1 piece
1.002.830	E1023412	0.203 kg	spare way cover width 50 mm, length 630 mm with level adjustment 123 mm for bus bar installation, set = cover + fixing set (2 distance pieces, 2 screw rivets)	bus bar system 185 mm	0.203 kg	1 set
1.002.829	F1023413	0.33 kg	spare way cover width 100 mm, length 630 mm with level adjustment 123 mm for bus bar installation set = cover + fixing set (2 distance pieces, 2 screw rivets)	bus bar system 185 mm	0.27 kg	1 set

### Installation devices/bus bar installation

Catalog number	Item number	Weight	Design	Weight	Package
1.002.648	T1023448	-	M12 insert nut, size 2 and 3 1 set = 30 pieces	0.28 kg	1 set
1.000.192	P1002284	0.467 kg	hooked clamp size 1, 2, 3, M = 15–20 Nm hexagon socket connection (inbus) for MULTIVERT®/BSL with top or bottom terminal 1 set = 3 pieces	0.467 kg	1 set

# MULTIVERT® 630A

Size 3, 690VAC

## ACCESSORIES



1.002.940

MZESM



1.000.829

1.000.852



1.000.102

1.000.103



1.000.104

1.000.109



1.002.294

1.002.295



1.002.291

### Indication facilities

Catalog number	Item number	Weight	Design	Weight	Package
1.002.940	Z1023453	0.159 kg	electronic fuse monitoring ESÜ size 1,2,3 for MULTIVERT® 250 A, 400 A, 630 A with cabling of instrument leads (rated voltage 525VAC)	0.85 kg	1 piece
MZESM	J228766	0.104 kg	Electronic System Monitor ESM size 1,2,3 for MULTIVERT® 250 A, 400 A, 630 A with cabling of instrument leads	0.104 kg	1 piece
1.000.829	L1023418	0.314 kg	electro-mechanical fuse monitoring (galvanic isolation) MZS size 1,2,3 for MULTIVERT® 250 A, 400 A, 630 A with cabling of instrument leads	0.314 kg	1 piece
1.000.852	Q1002285	9 g	indicator for switch door position micro switch, 1 change-over contact 5 A, 250 V	0.09 kg	1 piece

### Amperemeter units

Catalog number	Item number	Weight	Design	Weight	Package
1.000.102	M1023281	0.44 kg	size 1, 2, 3, 250 A, with drag indicator, single pole measurement	83 g	1 piece
1.000.103	N1023282	0.44 kg	size 2, 3, 400 A, with drag indicator, single pole measurement	83 g	1 piece
1.000.104	P1023283	0.44 kg	size 3, 630 A, with drag indicator, single pole measurement	83 g	1 piece
1.000.105	J1023278	0.44 kg	size 3, 1000 A, with drag indicator, single pole measurement	83 g	1 piece
1.000.108	T1023287	0.44 kg	size 1, 2, 3, 250 A, with drag indicator, triple pole measurement (optional L1, L2, L3)	83 g	1 piece
1.000.109	V1023288	0.44 kg	size 2, 3, 400 A, with drag indicator, triple pole measurement (optional L1, L2, L3)	83 g	1 piece
1.000.110	W1023289	0.44 kg	size 3, 630 A, with drag indicator, triple pole measurement (optional L1, L2, L3)	83 g	1 piece
1.000.111	Q1023284	0.44 kg	size 3, 1000 A, with drag indicator, triple pole measurement (optional L1, L2, L3)	83 g	1 piece

### Amperemeter for direct frontal installation

Catalog number	Item number	Weight	Design	Weight	Package
1.002.294	G1023276	0.14 kg	size 2/3, 400 / 200 / 5A, with drag indicator, for NH-measuring fuse link, single pole measurement	0.14 kg	1 piece
1.002.295	H1023277	0.14 kg	size 2/3, 600 / 300 / 5A, with drag indicator, for NH-measuring fuse link, single pole measurement	0.14 kg	1 piece

### NH-measuring fuse links

Catalog number	Item number	Weight	Design	Weight	Package
1.002.291	K1023417	0.94 kg	size 3, 630 A C.T. current = 600/5A or 300/5A, distance between plugs 50 mm	0.94 kg	1 piece

MERSEN reserves the right to change, update or correct, without notice, any information contained in this datasheet.

### ACCESSORIES



MZ3SW400

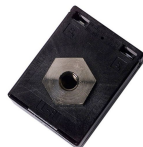

SZ1SW600



MZPR600

#### Current transformers/external current transformers

Catalog number	Item number	Weight	Design	Weight	Package
MZ1SW250	K1024567	0.88 kg	current transformer up to 250/5A for single pole measurement, class 1 set = 1 piece current transformer + 3 pieces distance tubes for level adjustment, 1 piece installed in the current transformer, 2 pieces additionally packed	0.88 kg	1 set
MZ1SW400	N1024570	0.89 kg	current transformer up to 400/5A for single pole measurement, class 1 set = 1 piece current transformer + 3 pieces distance tubes for level adjustment, 1 piece installed in the current transformer, 2 pieces additionally packed	0.89 kg	1 set
MZ1SW600	R1024573	1.22 kg	current transformer up to 600/5A for single pole measurement, class 1 set = 1 piece current transformer + 3 pieces distance tubes for level adjustment, 1 piece installed in the current transformer, 2 pieces additionally packed	1.22 kg	1 set
MZ1SW1000	E1024562	-	current transformer up to 1000/5A for single pole measurement, class 1 set = 1 piece current transformer + 3 pieces distance tubes for level adjustment, 1 piece installed in the current transformer, 2 pieces additionally packed	1.92 kg	1 set
MZ3SW250	M1024569	1.38 kg	current transformer up to 250/5A for triple pole measurement, class 1 set = 3 pieces current transformer with distance tubes for level adjustment, 3 pieces installed in the current transformer	1.38 kg	1 set
MZ3SW400	Q1024572	1.43 kg	current transformer up to 400/5A for triple pole measurement, class 1 set = 3 pieces current transformer with distance tubes for level adjustment, 3 pieces installed in the current transformer	1.43 kg	1 set
MZ3SW600	T1024575	1.275 kg	current transformer up to 600/5A for triple pole measurement, class 1 set = 3 pieces current transformer with distance tubes for level adjustment, 3 pieces installed in the current transformer	1.43 kg	1 set
MZ3SW1000	G1024564	2.47 kg	current transformer up to 1000/5A for triple pole measurement, class 1 set = 3 pieces current transformer with distance tubes for level adjustment, 3 pieces installed in the current transformer	2.47 kg	1 set
SZ1SW250	L1024568	-	current transformer up to 250/5A, class 1, for single pole measurement	0.43 kg	1 piece
SZ1SW600	S1024574	-	current transformer up to 600/5A, class 1, for single pole measurement	0.4 kg	1 piece
SZ1SW400	P1024571	-	current transformer up to 400/5A, class 1, for single pole measurement	0.46 kg	1 piece
SZ1SW1000	F1024563	-	current transformer up to 1000/5A, class 1, for single pole measurement	0.81 kg	1 piece
MZPR600	S1024597	-	distance tube for level adjustment, up to 600/5A, supplementary set for neighbouring MULTIVERT® without measurement to obtain uniform profile in height 1 set = 3 pieces	0.62 kg	1 set

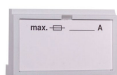

MZBT

#### Labelling facilities

Catalog number	Item number	Weight	Design	Weight	Package
MZBT	B222181	34 g	label holder size 1, 2, 3	0.03 kg	1 piece

### ACCESSORIES



1.002.909



1.002.910



22SZVK42



1.000.099



1.003.286



1.001.667



1.003.377



1.002.255

### Varieties of cable termination

Catalog number	Item number	Weight	Design	Weight	Package
1.002.909	K1024613	0.243 kg	V-terminal clamp size 1,2,3, 95-240 mm <sup>2</sup> single solid, 70-240 mm <sup>2</sup> single stranded, 50-185 mm <sup>2</sup> round stranded, 70-240 mm <sup>2</sup> round solid, M = 23 -27 Nm 1 set = 3 pieces	0.243 kg	1 set
1.002.910	L1024614	0.26 kg	V-terminal clamp size 1,2,3, 95-300 mm <sup>2</sup> single solid, 70-240 mm <sup>2</sup> single stranded, 50-185 mm <sup>2</sup> round stranded, 70-240 mm <sup>2</sup> round solid, M = 23 -27 Nm 1 set = 3 pieces	0.258 kg	1 set
22SZVK42	Q1024618	0.1736 kg	V-terminal clamp size 1,2,3 for 2 conductors 50-240 mm <sup>2</sup> single solid, 50-185 mm <sup>2</sup> single stranded, 50-185 mm <sup>2</sup> round stranded, 70-240 mm <sup>2</sup> round solid M = 23-27 Nm	6.8 g	1 piece
1.000.099	E1023436	0.1 g	insulation cap for V-terminal clamp size 1,2,3	0.1 g	1 piece
1.003.286	Q1024595	0.311 kg	supplementary set for V-terminal size 1,2,3 set = 3 pieces V-clamps, cover shroud and labels for size 1, 2 and 3	0.232 kg	1 set
1.001.667	F1023275	0.23 kg	adapter for double terminal L3	0.25 kg	1 piece
1.003.377	Y1024579	1.743 kg	supplementary set for multiple termination, top terminal 2 cable lugs Cu/Al: up to max. 300 mm <sup>2</sup> round stranded, sectoral stranded, 3 cable lugs Cu: up to max. 150 mm <sup>2</sup> round stranded, sectoral stranded, M = 32-38 Nm	1.743 kg	1 set
1.002.255	B1024582	1.682 kg	supplementary set for multiple termination, bottom terminal 2 cable lugs Cu/Al: up to max. 300 mm <sup>2</sup> round stranded, sectoral stranded, 3 cable lugs Cu: up to max. 150 mm <sup>2</sup> round stranded, sectoral stranded, M = 32-38 Nm	1.682 kg	1 set

MERSEN reserves the right to change, update or correct, without notice, any information contained in this datasheet.