

REHAUSSE R35
R35 STAND OFF BRACKET

Reference(s) : 586 650/54/57

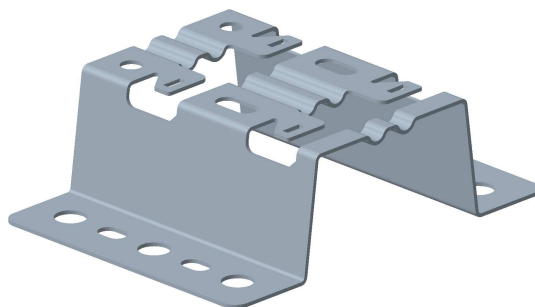

1. RANGE

Designation	Code	Poids* / Weight* (Kg) (lb)		Epaisseur / Thickness (mm) (inch)		Matière / Material	Norme / Standard	Finition / Coating	Norme / Standard
R35 GS	586 650	0.145	0.320	1.2	0.05"	DX 51 D Z275 MAC	EN 10346	GS / PG	
R35 ZM	586 657	0.145	0.320	1.2	0.05"	DX 51 D ZM140-310 MAC	EN 10346	ZM (ZnMg)	
R35 SS316L	586 654	0.148	0.327	1.2	0.05"	X2 Cr Ni Mo 17-12-2	EN 10088-2	INOX316L / SS316L	

2. DIMENSIONS (mm/inch)

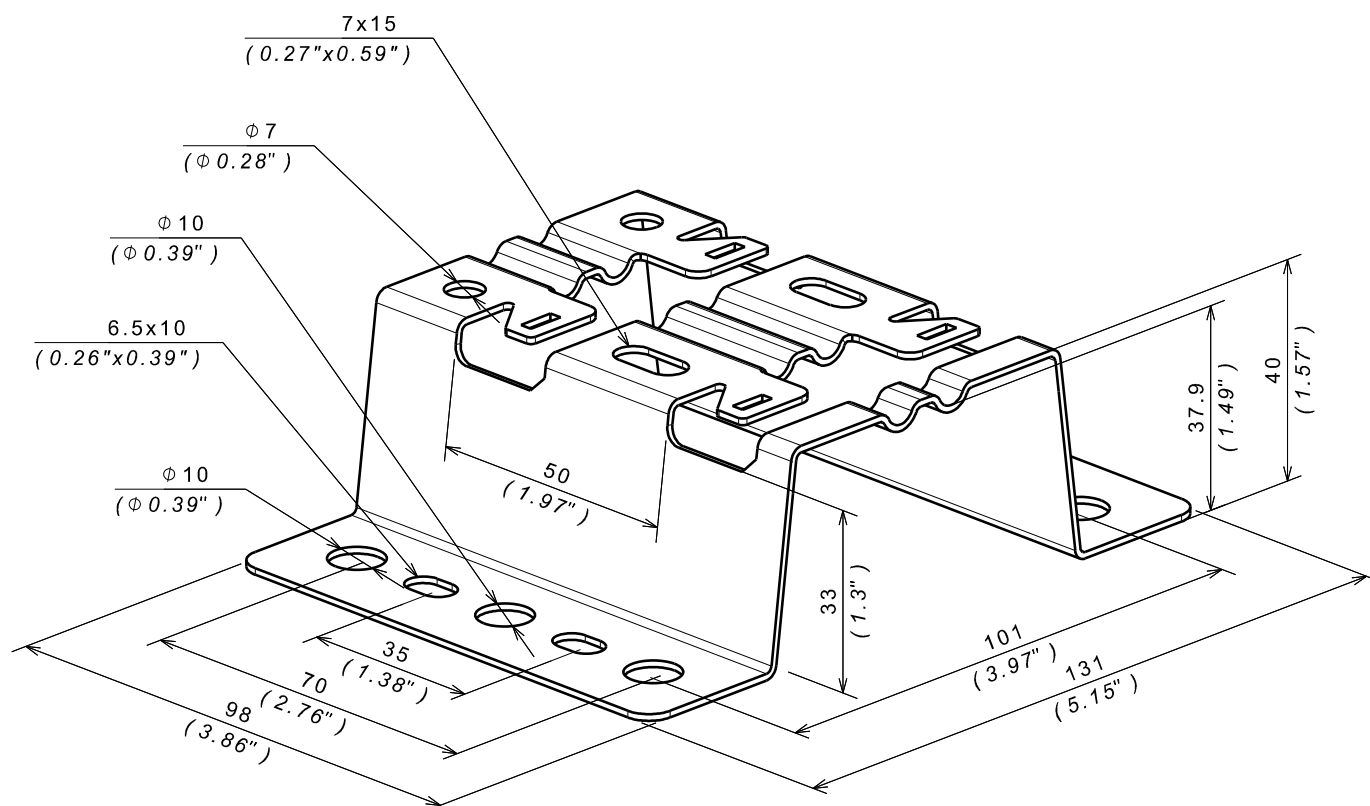

REHAUSSE R35
R35 STAND OFF BRACKET

Reference(s) : 586 650/54/57

3. INSTALLATION

