

CORNIERE COR 24 / 24
COR 24 / 24 ANGLE

GC
HDG

legrand | CABLE
MANAGEMENT

FT0259-3

03 16

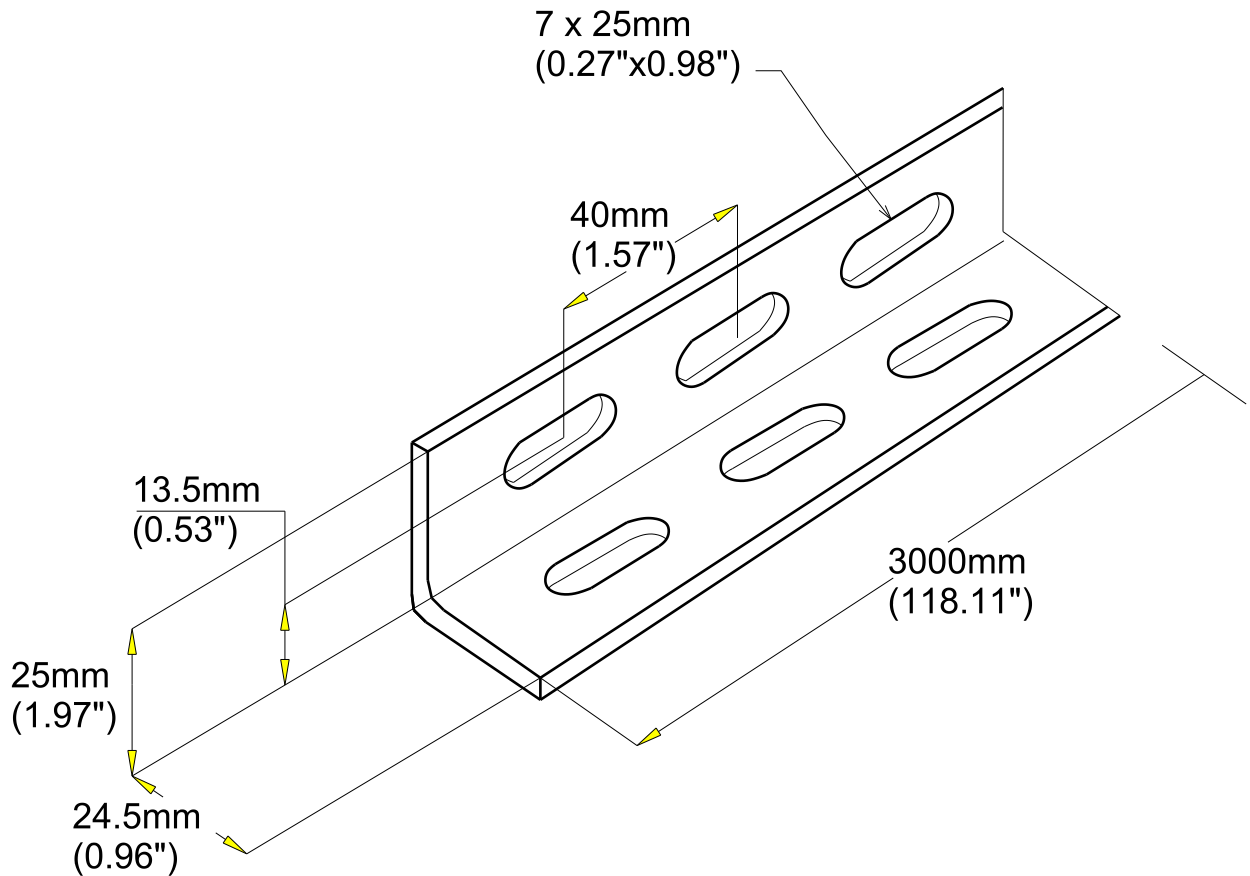

Material	Standard	Finishes	Standard
S235JR	EN 10025	Hot dip galvanized	EN ISO 1461

REF	CODE	POIDS (Kg/m)	WEIGHT (lb/ft)
COR 24/24	524 190	0.520	0.350

EPAISSEUR / THICKNESS
1.5 / (0.06")