











 <p>IP55</p>		1 ... 2,5 mm ²				
		1 ... 2,5 mm ²	- 20 ... + 50°C	- 20 ... + 70°C	<ul style="list-style-type: none"> > 10 ans > 10 jaare > 10 years > 10 Jahre > 10 años 	25 s ... 15 min

								
8 A cos φ = 1 / 250 V~	1840 W	400 VA	2 x 58 W 14μF	1000 W	400 W	250 VA	400 VA	400 VA
8 A cos φ = 1 / 250 B~	1840 Вт	400 ВА	2 x 58 W 14 мкФ	1000 Вт	400 Вт	250 ВА	400 ВА	400 ВА

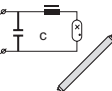
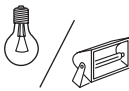
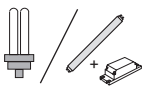

- Raccorder les appareils sur la même phase.
Si l'éclairage est allumé après la première installation sans qu'aucune touche n'ait été actionnée, presser l'interrupteur pendant plus de 2 secondes. Cette opération entraîne l'extinction de l'éclairage.

- De apparaten aansluiten op dezelfde fase.
Wanneer de verlichting is ingeschakeld na de eerste installatie zonder dat er een toets werd ingedrukt, drukt u 2 seconden lang op de schakelaar. Deze bewerking zorgt ervoor dat de verlichting wordt uitgeschakeld.

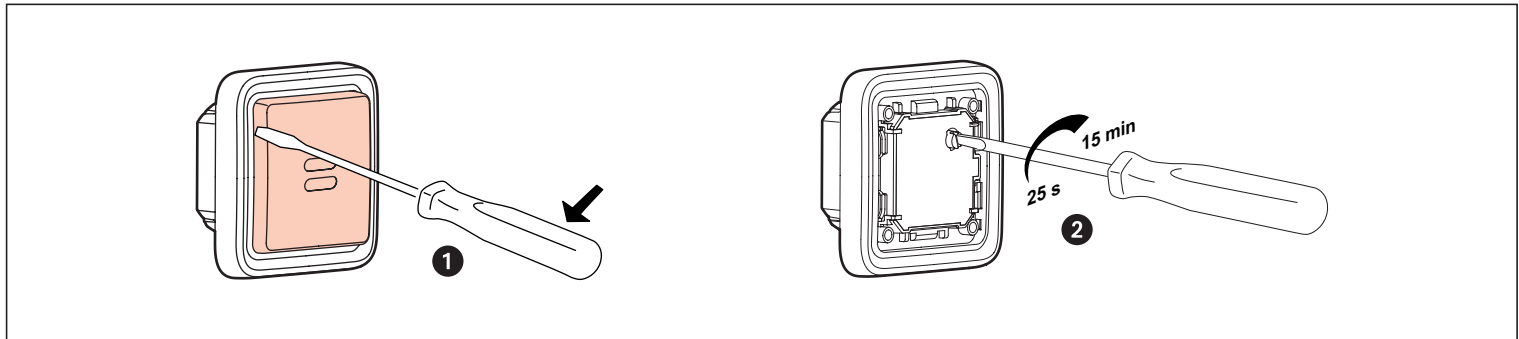
- Connect the devices on the same phase.
If lighting is on after the first installation without any key operation, then press the switch for more than 2 seconds. Lighting then goes off.

- Die Geräte müssen phasengleich angeschlossen werden.
Falls nach der ersten Installation die Beleuchtung ohne Tastenbetätigung eingeschaltet ist, betätigen Sie den Schalter länger als 2 Sekunden. Damit wird die Beleuchtung ausgeschaltet.

- Conectar los aparatos en la misma fase.
Si el alumbrado se enciende después de la primera instalación sin que se haya accionado ninguna tecla, pulsar el interruptor durante más de 2 segundos. De esta manera, se producirá el apagado del alumbrado.

- Устройства следует подсоединять к одной фазе. Если после подключения устройств освещение загорелось без нажатия клавиши, то необходимо нажать на клавишу выключателя в течение более 2 секунд, после чего освещение должно погаснуть.

