



by Schneider Electric

Installation Guide Smart-UPS™ X 750/1000/1500 VA Rack-Mount 2U

Important Safety Messages

SAVE THESE INSTRUCTIONS - This manual contains important instructions that should be followed during installation and maintenance of the Smart-UPS and batteries.

Read these instructions carefully and look at the equipment to become familiar with the device before trying to install, operate, service or maintain it. The following special messages may appear throughout this document or on the equipment to warn of potential hazards or to call attention to information that clarifies or simplifies a procedure.



The addition of this symbol either to a “Danger” or “Warning” safety label indicates that an electrical hazard exists which will result in personal injury if the instructions are not followed.



This is the safety alert symbol. It is used to alert you to potential personal injury hazards. Obey all safety messages that follow this symbol to avoid possible injury or death.

DANGER

DANGER indicates a hazardous situation which, if not avoided, will result in death or serious injury.

WARNING

WARNING indicates a hazardous situation which, if not avoided, could result in death or serious injury.

CAUTION

CAUTION indicates a hazardous situation which, if not avoided, could result in minor or moderate injury.

NOTICE

NOTICE is used to address practices not related to physical injury.

Product Handling Guidelines

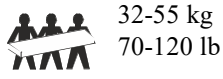
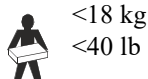

Safety and General Information

Inspect the package contents upon receipt. Notify the carrier and dealer if there is any damage.

Read the Safety Guide supplied with this unit before installing the UPS.

- Adhere to all local and national electrical codes.
- This UPS is intended for indoor use only.
- Do not operate this UPS in direct sunlight, in contact with fluids, or where there is excessive dust or humidity.
- Be sure the air vents on the UPS are not blocked. Allow adequate space for proper ventilation.
- The battery typically lasts for two to five years. Environmental factors impact battery life. Elevated ambient temperatures, poor quality utility power, and frequent short duration discharges will shorten battery life.
- Connect the UPS power cable directly to a wall outlet. Do not use surge protectors or extension cords.

Battery

CAUTION

RISK OF HYDROGEN SULPHIDE GAS AND EXCESSIVE SMOKE

- Replace the battery at least every 5 years.
- Replace the battery immediately when the UPS indicates battery replacement is necessary.
- Replace battery at the end of its service life.
- Replace batteries with the same number and type of batteries as originally installed in the equipment.
- Replace the battery immediately when the UPS indicates a battery over temperature condition, or UPS internal over temperature, or when there is evidence of electrolyte leakage. Power off the UPS, unplug it from the AC input, and disconnect the batteries. Do not operate the UPS until the batteries have been replaced.
- *Replace all battery modules (including the modules in External Battery Packs) which are older than one year, when installing additional battery packs or replacing the battery module(s).

Failure to follow these instructions could result in equipment damage and minor or moderate injury.

*Contact APC by Schneider Electric Worldwide Customer Support to determine the age of the installed battery modules.

Inventory

All models

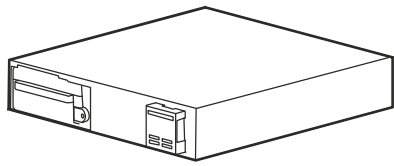

(1)

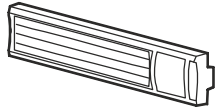

(1)

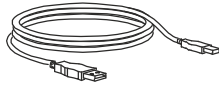

(1)

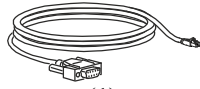

(1)

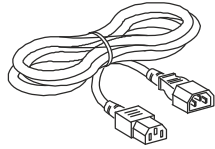

(2)

230 Vac models



(4)



(4)

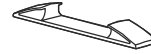

(2)



(1 pair)

Rack-Mount brackets

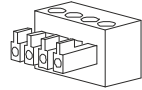



(1)



(4)

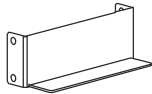

(1)

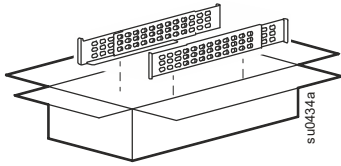
750/1000 VA models				1500 VA models
				
(2)	(2)	(4)	(2)	(1 pair)

Models with preinstalled network cards

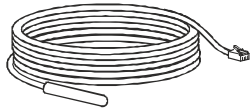

Installation

Connect the battery

⚠ CAUTION

DAMAGE TO EQUIPMENT OR PERSONNEL

- The equipment is heavy. Always practice safe lifting techniques adequate for the weight of the equipment.
- Connect the battery after installing the UPS in a rack.

Failure to follow these instructions could result in equipment damage and minor or moderate injury.

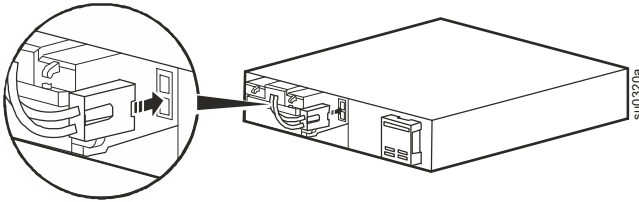

Tower to rack-mount conversion 750/1000 VA

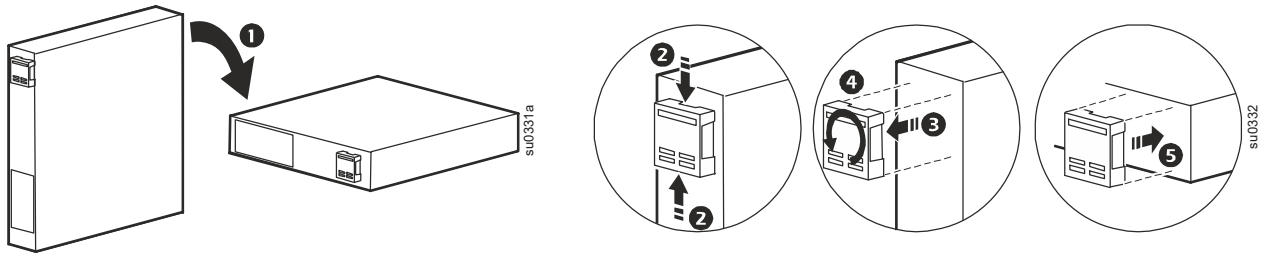

Rack-mount to tower conversion 1500 VA

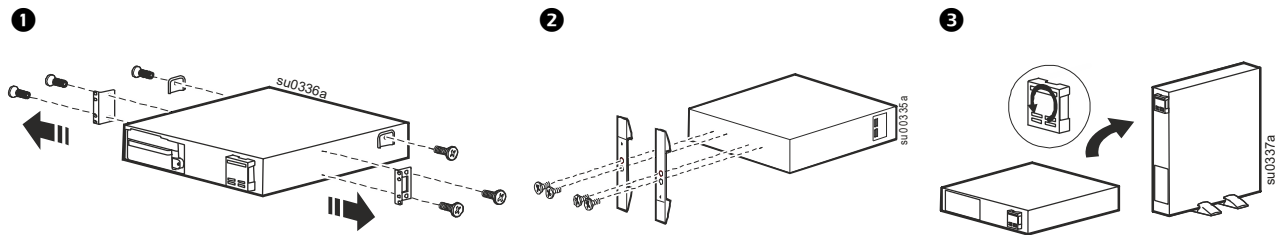

Two post rack

Front mount installation 750/1000 VA

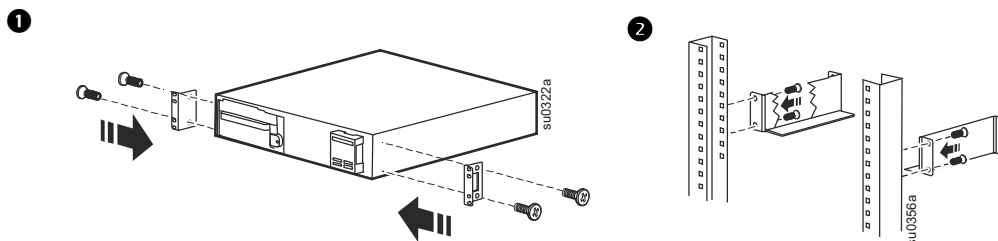

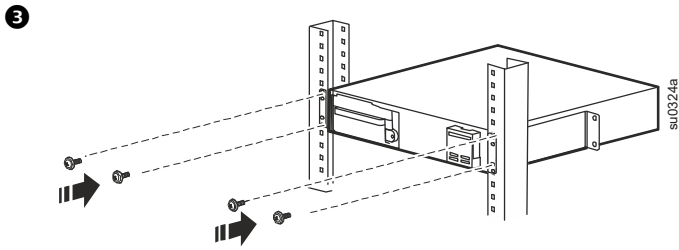

Center mount 750/1000/1500 VA

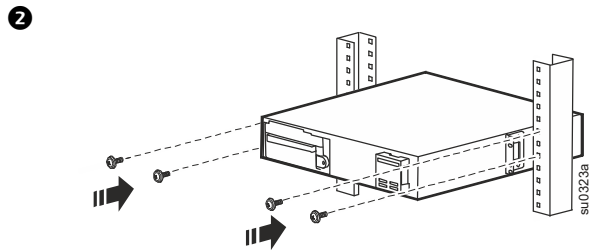
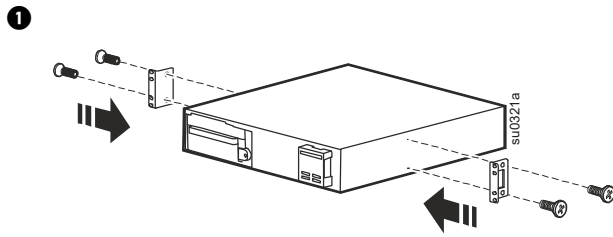

Four post rack installation 1500 VA

Use the APC Four Post Rail Kit (included with 1500 VA models only.)

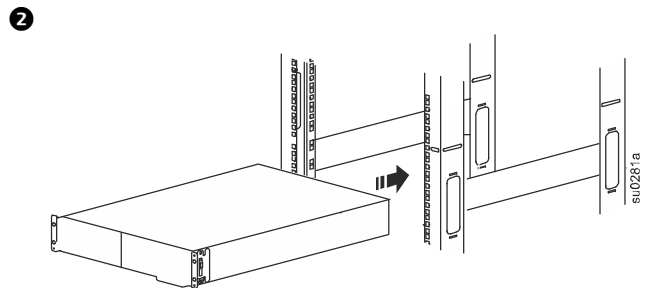
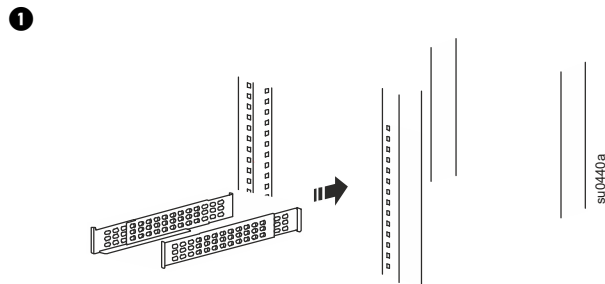

Install the bezel and rotate the logo

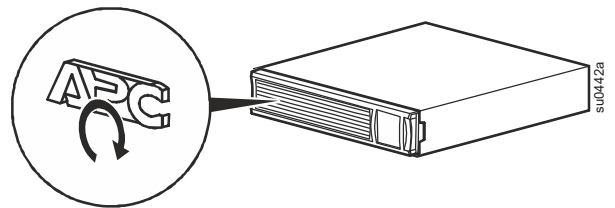
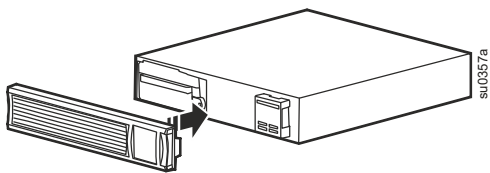

Start Up and Configuration

Overview

120 Vac

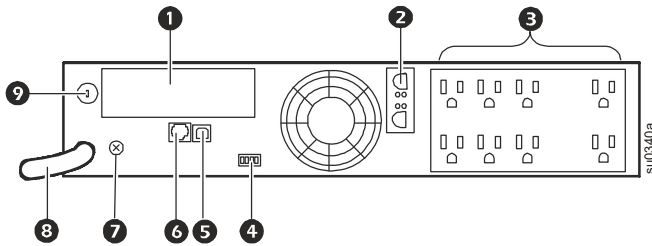

- ❶ SmartSlot
- ❷ External battery pack connector
- ❸ Outlets
- ❹ EPO connector
- ❺ USB port
- ❻ Serial port
- ❼ Chassis ground screw
- ❽ UPS input
- ❾ Circuit breaker

230 Vac

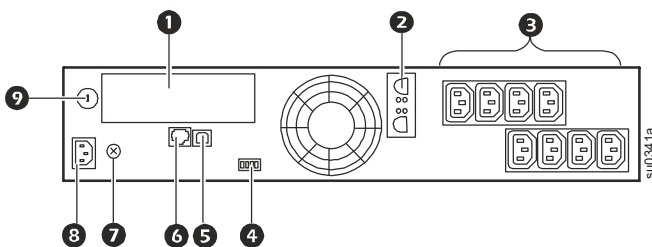

Controllable outlet groups

The outlets on the UPS are configured into groups. To configure the controlled outlet features, navigate to: **Main Menu > Control > Outlet1 Control**.

SKU	Controllable Outlet Group
750 VA	1
1000 VA	1 and 2
1500 VA	1, 2, and 3

Examples of switched outlet groups

230 V 1500 VA

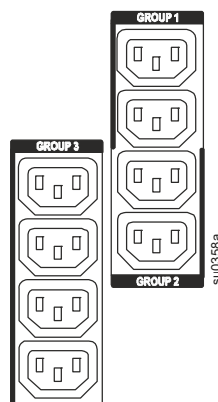

120 V 1500 VA

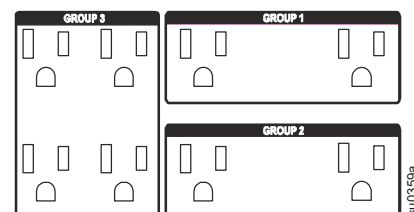

Electrical connections

⚠ CAUTION

HAZARD OF ELECTRICAL SHOCK

- Adhere to all local and national electrical codes.
- Wiring should be performed by qualified electrician.
- Always connect the UPS to a grounded outlet.

Failure to follow these instructions could result in minor or moderate injury.

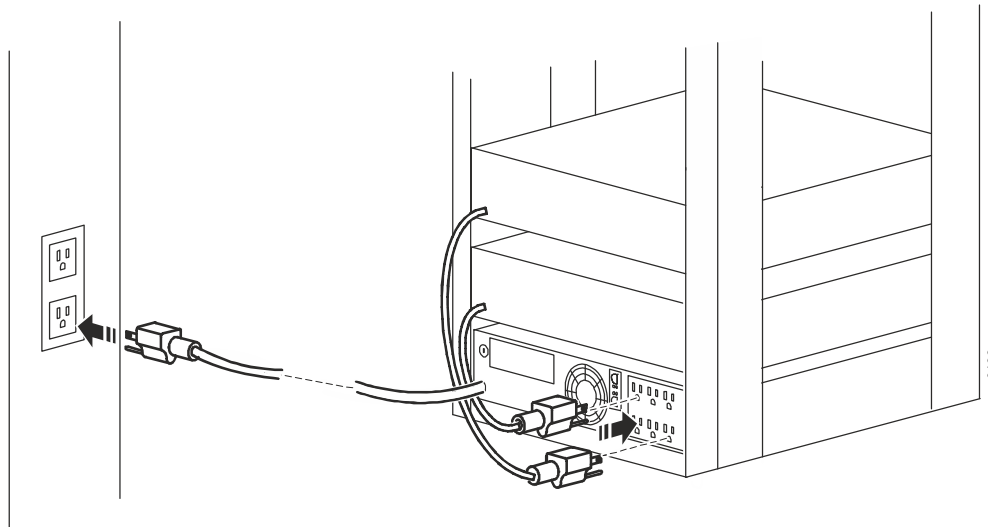

Display Interface

